



AMBIANCE®
FIREPLACES | GRILLS



WARNING: If the information in this manual is not followed exactly, a fire or explosion may result causing property damage, personal injury or loss of life.

Do not store or use gasoline or other flammable vapors or liquids in the vicinity of this or any other appliance.

WHAT TO DO IF YOU SMELL GAS:

- Do not try to light any appliance
- Do not touch any electrical switch; do not use any phone in your building
- Immediately call your gas supplier from a neighbors phone.
- Follow the gas suppliers instructions
- If you can not reach your gas supplier, call the fire department

Installation and service must be performed by a qualified installer, service agency or the gas supplier.

English and French Installation Manuals available through your local dealer or visit our website at: www.archgard.com
Les manuels d'installation en anglais et en français son disponibles chez votre détaillant local ou en visitant notre site web: www.archgard.com

INSTALLER:
LEAVE THIS MANUAL WITH THE APPLIANCE.

CONSUMER:
RETAIN THIS MANUAL FOR FUTURE REFERENCE.

ARCHGARD FIREPLACE PRODUCTS
7116 Beatty Drive
Mission, BC V2V 6B4 Canada

**INSTALLATION, OPERATION, AND
MAINTENANCE MANUAL**

Inspiration 34

**MODEL: UF0600
UF0610**

**GAS FIRED DIRECT VENT
FIREPLACE INSERT
S/N 630938 AND UP**

This appliance may be installed in an aftermarket permanently located, manufactured home (USA only) or mobile home where not prohibited by local codes.

This appliance is only for use with the type of gas indicated on the rating plate. This appliance is not convertible for use with other gases, unless a certified kit is used.

! DANGER



**HOT GLASS WILL
CAUSE BURNS.
DO NOT TOUCH GLASS
UNTIL COOLED.
NEVER ALLOW CHILDREN
TO TOUCH GLASS.**

A barrier designed to reduce the risk of burns from the hot viewing glass is provided with this appliance and must be installed for the protection of children and other at-risk individuals.



We recommend that our gas hearth products be installed and serviced by professionals who are certified in the U.S. by the National Fireplace Institute® (NFI) as NFI Gas Specialists.

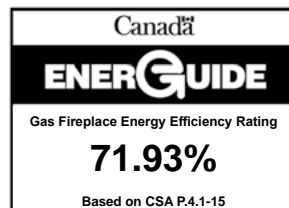

200-0600-12
February 22, 2024

TABLE OF CONTENTS

1.0 Introduction	3	15.0 Glass Door Installation	26
2.0 Safety Information	4	15.1 If Your Glass Breaks.....	27
3.0 Technical Information	5	16.0 Surround Installation	28
3.1 Appliance Certification.....	5	16.1 Surround Dimensions.....	29
3.2 Installation Codes.....	5	16.2 Bottom Trim Dimensions.....	31
3.3 Specifications.....	5	16.3 Bottom Filler Plate.....	32
3.4 High Altitude Installation.....	5	17.0 Firebox Liner Installation	33
4.0 Rating Plate	6	17.1 Brick Panel Installation.....	33
5.0 Installation Checklist	7	17.2 Reflective Glass Installation.....	35
6.0 Appliance Overview	8	18.0 Media Installation	37
6.1 Rating Plate Location.....	8	18.1 Log Set (UF0600).....	37
6.2 Appliance Overview.....	8	18.2 Fire Beads (UF0610).....	42
6.3 Leveling the Appliance.....	8	18.3 River Rocks (UF0610).....	43
6.4 Accessing the Control Board.....	9	19.0 Operation	44
7.0 Electrical Connections	9	19.1 Before Lighting.....	44
8.0 Appliance Dimensions	10	19.2 First Fire.....	44
9.0 Minimum Opening Dimensions	11	19.3 Lighting Instructions.....	45
9.1 Factory Built Fireplaces.....	12	19.4 Dynamic Start Advantage.....	46
9.2 Refacing a Masonry Fireplace.....	13	19.5 Remote Control Operation.....	47
10.0 Clearances to Combustibles	14	20.0 Maintenance	54
10.1 Mantel Clearances.....	14	20.1 Cleaning the Appliance.....	54
10.2 Sidewall Clearances.....	14	20.2 Servicing Under Warranty.....	55
10.3 Hearth Clearances.....	15	20.3 Checking Inlet and Outlet Pressure.....	55
10.4 Hearth Protection.....	15	20.4 Checking and Adjusting Pilot.....	55
10.5 Heat Sensitive Flooring Materials.....	16	20.5 Adjusting the Primary Air.....	56
11.0 Gas Connections	17	20.6 Replacing Batteries.....	57
11.1 Clocking Procedure.....	17	20.7 Replacing Fuse.....	57
12.0 Conversion Kit Instructions	18	20.8 Replacing Light Bulbs.....	58
12.1 Prepare the Fireplace.....	18	20.9 Replacing the Control Board.....	59
12.2 Pilot Conversion.....	18	20.10 Replacing the Burner.....	61
12.3 Convert the Gas Valve.....	19	20.11 Replacing the Pilot.....	63
12.4 Complete the Conversion.....	19	20.12 Replacing the Fan.....	66
13.0 Venting Instructions	20	20.13 Replacing Light Bases.....	68
13.1 Approved Terminations.....	20	20.14 Wiring Schematic.....	70
13.2 Vent Slider Installation.....	22	20.15 Troubleshooting.....	71
13.3 Min/Max Vent Run.....	23	21.0 Frequently Asked Questions	72
13.4 Using a Co-linear to Coaxial Adapter.....	24	22.0 Replacement Parts List	73
14.0 Barrier Screen Installation	25	Limited Warranty	74

1.0 Introduction

Thank You and Congratulations for choosing an Ambiance Gas Fireplace!

The UF0600 / UF0610 is one of the most advanced Direct Vent Insert heaters available today. It is solidly designed using the latest technology and manufactured to the highest quality. It is our aim to provide you with an appliance that brings many trouble-free years of reliable service.

Some of the many features of your UF0600 / UF0610 are:

- **Heater Classification** This fireplace is classified as a heating appliance. Therefore, it uses Direct Vent safety technology and it is suitable for continuously operated zone heating.
- **High Efficiency** This fireplace has one of the highest efficiencies of any Direct Vent gas insert, ensuring it is less expensive to operate.
- **Adjustable Fan Speed** This fireplace comes complete with an adjustable six speed circulation fan controlled with the remote.
- **Adjustable Flame** This fireplace provides the ability to adjust the flame aesthetics and heat output to suit the owner's liking and heating needs.
- **Adjustable Lighting** Use the included remote to choose from six levels of accent lighting or leave the light off and allow the flame to provide a flickering glow.
- **Solid Construction** This fireplace is mainly constructed of 16 and 18 gauge galvanized and aluminized coated steel for long life and durability.
- **Optional Accessories** Speak with your local Authorized Ambiance Dealer for a full complement of decorative accessories to suit your home's decor and personal tastes.
- **Electronic Control System** This fireplace comes standard with the Dynamic Start Advantage. This new electronic ignition system is the latest in fireplace technology. It helps to create a better draft, better flame appearance, less condensation on the glass, and years of carefree operation. See **Section 19.4** for complete explanation of how the system works.
- **Multiple Electronic Pilot Settings** This fireplace uses a gas control valve that is operated by a Multifunction Remote Control. It can be set up as either an Intermittent Pilot Ignition (IPI) system, or Continuous Pilot on Demand Ignition (CPI) system (also known as a Pilot on Demand (POD)).

CPI vs IPI:

Continuous Pilot on Demand Ignition (CPI): In this mode the pilot runs continuously even when the main burner is off. The Continuous Pilot on Demand Ignition operates on a seven day cycle. If the main burner is not turned on for seven continuous days, the pilot will turn itself off. When the main burner is lit again the cycle repeats. The pilot will remain lit for seven days, even after the main burner is turned off. If the main burner is lit during a seven day timing cycle, the seven day timer will reset.

Intermittent Pilot Ignition (IPI): A fuel saving mode in which the pilot is only used when the main burner is on.

This appliance is shipped in IPI mode. IPI mode is often the preferred method, however, there are some situations where it may be preferable to switch the fireplace into CPI mode. For example, in colder climates the glass door or the front of the fireplace could become very cold to the touch. Dynamic Start Advantage will solve most problems experienced by older IPI operated fireplaces.

2.0 Safety Information

Caution

FOR YOUR SAFETY - Do not install or operate your UF0600 / UF0610 without reading and understanding this manual. Any installation or operational deviation from this instruction manual voids the warranty and may prove hazardous.

This appliance must be installed by a qualified gas installer and the installation must conform to the installation codes.

Provide adequate clearance around air openings into combustion chamber.

Never obstruct front openings.

Provide adequate clearances for proper operation and servicing of the appliance.

This appliance must be properly connected to an approved venting system and must not be connected to a chimney flue serving a separate solid fuel burning appliance.

Flow of combustion and ventilation air must not be obstructed.

Always provide adequate clearance around the intake and exhaust openings.

Safety

Due to high temperatures, the appliance should be located out of traffic and away from furniture and draperies.

Children and adults should be alerted to the hazards of high surface temperature and stay away to avoid burns or clothing ignition.

Young children should be carefully supervised when they are in the same room as the appliance. Toddlers, young children and others may be susceptible to accidental contact burns. A physical barrier is recommended if there are at risk individuals in the house. To restrict access to a fireplace or stove, install an adjustable safety gate to keep toddlers, young children and other at risk individuals out of the room and away from hot surfaces.

Do not store or place combustibles, gasoline, and other flammable vapors and liquids near the appliance.

Clothing or other flammable material should not be placed on or near the appliance.

Do not operate with cracked or broken glass. Do not to strike or slam the glass.

WARNING: Do not operate appliance with the glass front removed, cracked, or broken. Removal of the glass should be done by a licensed or qualified service person.

Any safety screen or guard removed for servicing an appliance must be replaced prior to operating.

Installation and Repair should be done by a qualified service person. The appliance should be inspected before use and at least annually by a professional service person. More frequent cleaning may be required due to excessive lint from carpeting, bedding materials, etc. It is imperative that the control compartments, burners and circulating air passageways of the appliance are kept clean.

Do not use this appliance if any part has been under water. Immediately call a qualified service technician to inspect the appliance and to replace any part of the control system and any gas control which has been under water.

California Proposition 65 Warning: This product can expose you to chemicals including Carbon Monoxide, that is an externally vented by-product of fuel combustion, which is [are] known to the State of California to cause cancer, birth defects, or other reproductive harm. For more information, visit www.P65Warnings.ca.gov.

Each Ambiance Gas Fireplace is checked and tested at the factory prior to being packaged and shipped to our dealers and finally installed in your home. Before leaving this unit with the customer, the installer must ensure that the appliance is firing correctly and that the electrical system is in working order. The Installation Checklist in **Section 5.0** should be used to ensure the proper installation of this gas fireplace insert and to document any deviations from a typical install.

Any alteration to the product that causes carbon or soot deposits that results in any damage or requires cleaning is not the responsibility of the manufacturer.

3.0 Technical Information

3.1 Appliance Certification

This appliance was listed by QAI Laboratories Inc to the following USA and Canadian gas appliance standards.

- ANSI Z21.88-2019 / CSA 2.33-2019 Vented Gas Fireplace Heaters
 - CAN/CGA-2.17-M91(R2014), Gas-Fired Appliances for Use at High Altitudes
 - CSA P.4.1-15 testing method for measuring annual fireplace efficiency
 - CSA C22.2 No.3 - M1998(R.2014) - Electrical Features of Fuel-Burning Equipment
- The listing label is attached to the appliance on the bottom right side of the appliance.
A copy is shown on **Section 4.0**.

Commonwealth of Massachusetts: This appliance has been manufactured in accordance with Massachusetts code 248 CMR 5.00. Approval Code: **G1-1216-246**. (<http://www.mass.gov/ocabr/licensee/dpl-boards/pl/>).

Please contact **Archgard Industries Ltd.**, if you have any questions regarding the certification of this appliance.

3.2 Installation Codes

This appliance must be installed by a qualified gas appliance installer. The installation must conform with the local codes or, in the absence of local codes, with the current National Fuel Gas Code ANSI Z223.1/ NFPA 54 in the US, or Installation Code CAN/CGA-B149.1 in Canada. Electrical connections and grounding must conform with local code, or current National Electrical code ANSI/NFPA No. 70-1987 in the US, and in Canada the current Canadian Electrical Code CSA C22.1.

We recommend that our gas hearth products be installed and serviced by professionals who are certified in the U.S. by the National Fireplace Institute® (NFI) as NFI Gas Specialists.

3.3 Specifications

	Natural Gas (NG)	Propane (LP)
Manifold Pressure	1.1 - 3.8 in. W.C. (0.3 - 0.9 kPa)	2.9 - 11.0 in. W.C. (0.7 - 2.7 kPa)
Min. Supply Pressure	5.0 in. W.C. (1.2 kPa)	12.0 in. W.C. (2.7 kPa)
Max Supply Pressure	14.0 in. W.C. (3.5 kPa)	14.0 in. W.C. (3.5 kPa)
Orifice Size	#31 DMS (3.05 mm dia.)	#47 DMS (1.99 mm dia.)
Input Rating	21,000 - 40,000 BTU/hr (6.15 - 11.72 kW)	20,000 - 40,000 BTU/hr (5.86 - 11.72 kW)
P.4 Fireplace Efficiency (FE)	71.93%	
P.4 Steady State Efficiency	73.64%	
Electrical Rating	120 VAC, 60 Hz less than 2 A.	
Gas Control	SIT 885 Proflame II Dynamic Start Advantage with Continuous Pilot on Demand	
Altitude	0 - 4500 ft (0 - 1372 m)	
Primary Air Opening	1/8" (3mm) Open	1/2" (12.7mm) Open

3.4 High Altitude Installation

When installing this appliance beyond 4500 ft. (1372 M) above sea level, the appliance must be properly derated and installed according to local codes, in the absence of local codes, with the current National Fuel Gas Code, ANSI Z223.1/ NFPA 54, in the US or Installation Code, CAN/CGA-B149.1, in Canada.

4.0 Rating Plate

DO NOT REMOVE THIS LABEL



AMBIANCE®
FIREPLACES | GRILLS

MODEL: UF0600 (SIT 885 Proflame)

LISTED VENTED GAS FIREPLACE HEATER and GAS-FIRED APPLIANCES FOR USE AT HIGH ALTITUDES. Tested to: ANSI Z21.88-2019 / CSA 2.33-2019, CAN/CGA 2.17-M91 (R2014), CSA P.4.1-15, and CSA 22.2 No.3-M1988 (R2014). This vented gas fireplace heater is not for use with air filters. Certified for use in both CANADA and USA.

VENTED GAS FIREPLACE HEATER-NOT FOR USE WITH SOLID FUEL.
Manufactured as Natural Gas

	NG	LPG
Input rating	21,000 - 40,000 BTU/hr (6.15 - 11.72 kW)	20,000 - 40,000 BTU/hr (5.86 - 11.72 kW)
Manifold Pressure	1.1 - 3.8 in. W.C. (0.3 - 0.9 kPa)	2.9 - 11.0 in. W.C. (0.7 - 2.73 kPa)
Orifice size	#31 DMS (3.05 mm dia.)	#47 DMS (1.99 mm dia.)
Supply pressure (Min - Max)	5.0 - 14.0 in. W.C. (1.2 - 3.5 kPa)	12.0 - 14.0 in. W.C. (2.7 - 3.5 kPa)
Burner Primary Air Setting	1/8" (3mm) Open	1/2" (12.7mm) Open
Altitude	0 - 4500 ft (0 - 1372 m)	0 - 4500 ft (0 - 1372 m)
Gas Control	SIT 885 Proflame II Dynamic Start with Continuous POD	
Electrical rating	120 VAC, 60 Hz, less than 2 A.	
P.4.1 Fireplace Efficiency (FE)	71.93%	
Replacement fan	Part # UR-305-0624 fan or blower assembly must be used	
Keep burner and control compartment clean. See Instructions accompanying the heater. Optional fuel conversion kit : See Manual	Minimum opening Dimensions: 34" (864 mm)W x 24" (610 mm)H x 16" (406 mm)D Minimum Chimney Flue Size: 4" (102 mm) x 7" (178 mm) Minimum clearances to Combustibles: Sides from glass door frame: 8" (203 mm) Max 8" (203 mm) mantle at min 24" (610 mm) from top of appliance door. See Manual for additional dimensions and clearances	

This appliance must be installed in accordance with local codes, if any; if none, follow the National Fuel Gas Code, ANSI Z223.1/NFPA 54, or Natural Gas and Propane Installation Codes, CSA B149.1. Electrical connections and grounding must be in accordance with local codes, if any; if none, follow the current CAN/CSA C22.1 in Canada and ANSI/NFPA 70 in the US. This appliance is certified for installation in a bedroom or a bed sitting room. This appliance is only for use with the gas indicated on the rating plate and may be installed in an aftermarket, permanently located, manufactured (mobile) home where not prohibited by local codes. See owner's manual for details. This appliance is not convertible with other gases, unless a certified kit is used.

WARNING: Improper installation, adjustment, alteration, service, or maintenance can cause injury or property damage. Refer to the owner's information manual provided with this appliance. For assistance or additional information consult a qualified installer, service agency, or the gas supplier. This appliance must be properly connected to a Direct Vent venting system in accordance with the manufacturer's installation instructions.

WARNING: Failure to install this appliance per the manufacturer's instructions or failure to use only parts specifically approved with this appliance may result in property damage or personal injury.

WARNING: Do not operate the appliance until all sections have been assembled and installed in accordance with the manufacturer's instructions.

WARNING: Operation of this appliance when not connected to a properly installed and maintained venting system can result in carbon monoxide (CO) poisoning and possible death.

ONLY DOORS CERTIFIED WITH THE APPLIANCE SHALL BE USED.
For use only with barrier part # URP-891-0200. Follow installation instructions.

Made in Canada by:
Archgard Industries Ltd.
7116 Beatty Dr., Mission, B.C.

November 2021 303-6060-06

MANUFACTURE DATE:



5.0 Installation Checklist

This standard installation checklist is to be used by the installer in conjunction with, not instead of, the instructions contained within this installation manual.

Customer: _____ Install Address: _____	Date Installed: _____ Location of Fireplace: _____ Installer: _____
---	--

Solid Fuel Zero Clearance Install: (Section 9.1)	YES	NO	IF NO, WHY NOT?
Was the bottom of the existing zero clearance removed?			
Was a 1/4" (6.35 mm) minimum clearance maintained as shown in Figure 9.1.02 ?			

Venting: (Section 13)	YES	NO	IF NO, WHY NOT?
Venting configuration complies with vent diagrams.			
Venting installed, fastened, and secured in place maintaining proper clearances.			
Secured or removed existing solid fuel fireplace damper.			
Terminations installed and sealed in compliance with local building code.			
Direct vent termination is highest point in vent assembly.			

Wiring / Electrical: (Section 7)	YES	NO	IF NO, WHY NOT?
Connected to household 110/120v per local codes.			
Unit is properly grounded.			

Gas: (Section 11)	YES	NO	IF NO, WHY NOT?
Proper appliance for fuel type?			
Was a conversion performed?			
Leak check performed & inlet and manifold pressures verified?			
Was the rating of the insert clocked?			

Finishing:	YES	NO	IF NO, WHY NOT?
Only noncombustible material installed in noncombustible areas.			
Clearances meet installation manual requirements.			
Mantels and/or projections comply with install manual.			
Was the solid fuel fireplace warning plate installed (Figure 9.0.02)?			

Appliance Setup:	YES	NO	IF NO, WHY NOT?
Burner media / log set, door, and screen installed according to install manual.			
Manual given to home owner.			
Did you check operation of lights, fans, and flame modulation?			

Comments:

6.0 Appliance Overview

6.1 Rating Plate Location



Figure 6.1.01:

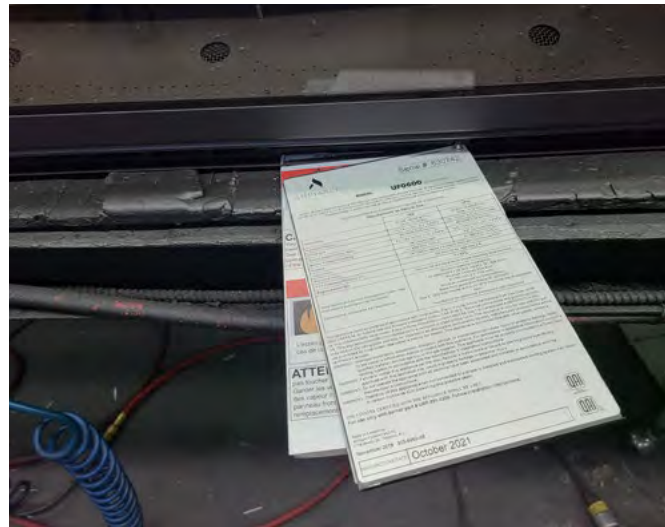

Figure 6.1.02:

6.2 Appliance Overview

Information in this manual applies to both the UF0600 and UF0610 unless otherwise specified.

The Proflame II control board is located on the right side* of the fireplace behind the surround.

The valve is located on the left side* of the fireplace behind the surround.

The fan is located on the inside of the rear fireplace shell and can only be accessed from the rear of the fireplace.

Note: This manual uses images of an unpainted fireplace for the purposes of illustration.

*Left and right side references in this manual correspond with the sides identified in **Figure 6.2.01**.

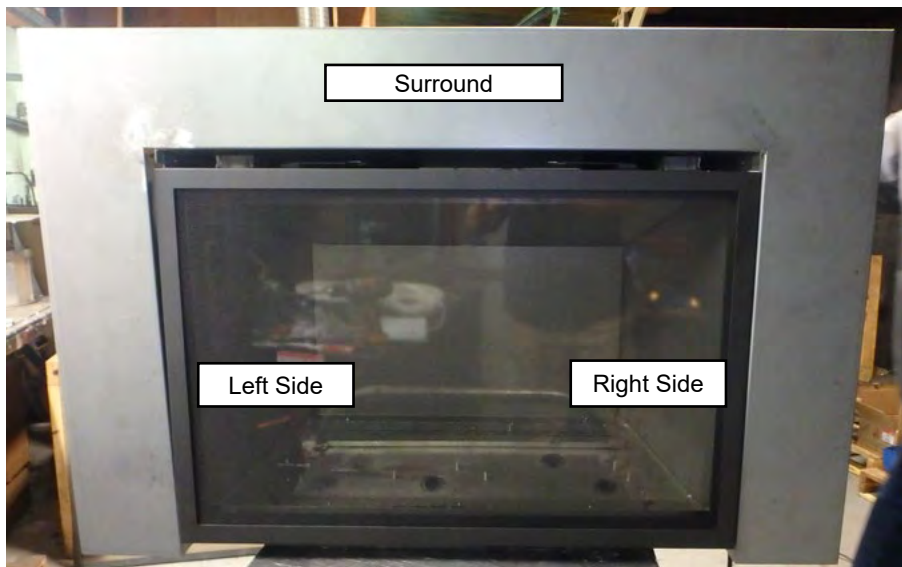

Figure 6.2.01:

6.3 Leveling the Appliance

The UF0600 / UF0610 is equipped with front and rear leveling bolts. The fireplace has the ability to independently level left/right and front/back.

Leveling is done from the bottom of the unit



Figure 6.3.01:

6.4 Accessing the Control Board

The control board is located on the right side of the fireplace, behind the fireplace surround. To access the control board:

1. Remove the surround (See **Section 14.0**).
2. Slide the control board forward as shown in **Figure 6.2.01**.

Ensure wires are not pinched or over-extended when moving the control board.

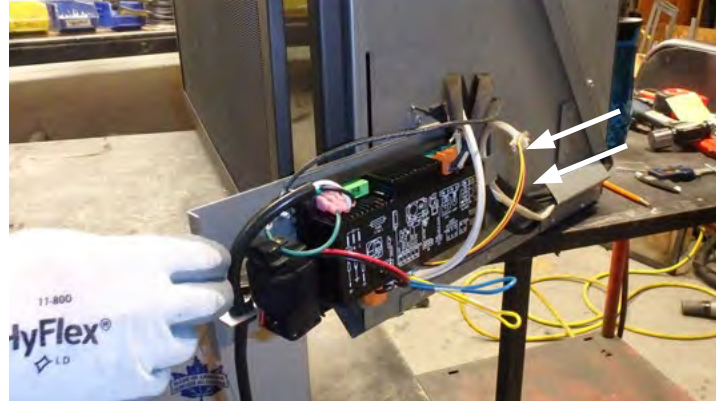

Figure 6.4.01:

7.0 Electrical Connections

The UF0600 / UF0610 comes complete with an adjustable 6 speed fan and variable lights wired directly to the main control module.

Do not cut or remove the grounding prong from the main power supply plug.

CAUTION: Label all wires prior to disconnection when servicing.

NOTE: This appliance, when installed, must be electrically grounded in accordance with local codes or, in the absence of local codes, with the National Electrical Code, ANSI / NFPA 70, or the Canadian Electrical code, CSA C22.1.

8.0 Appliance Dimensions

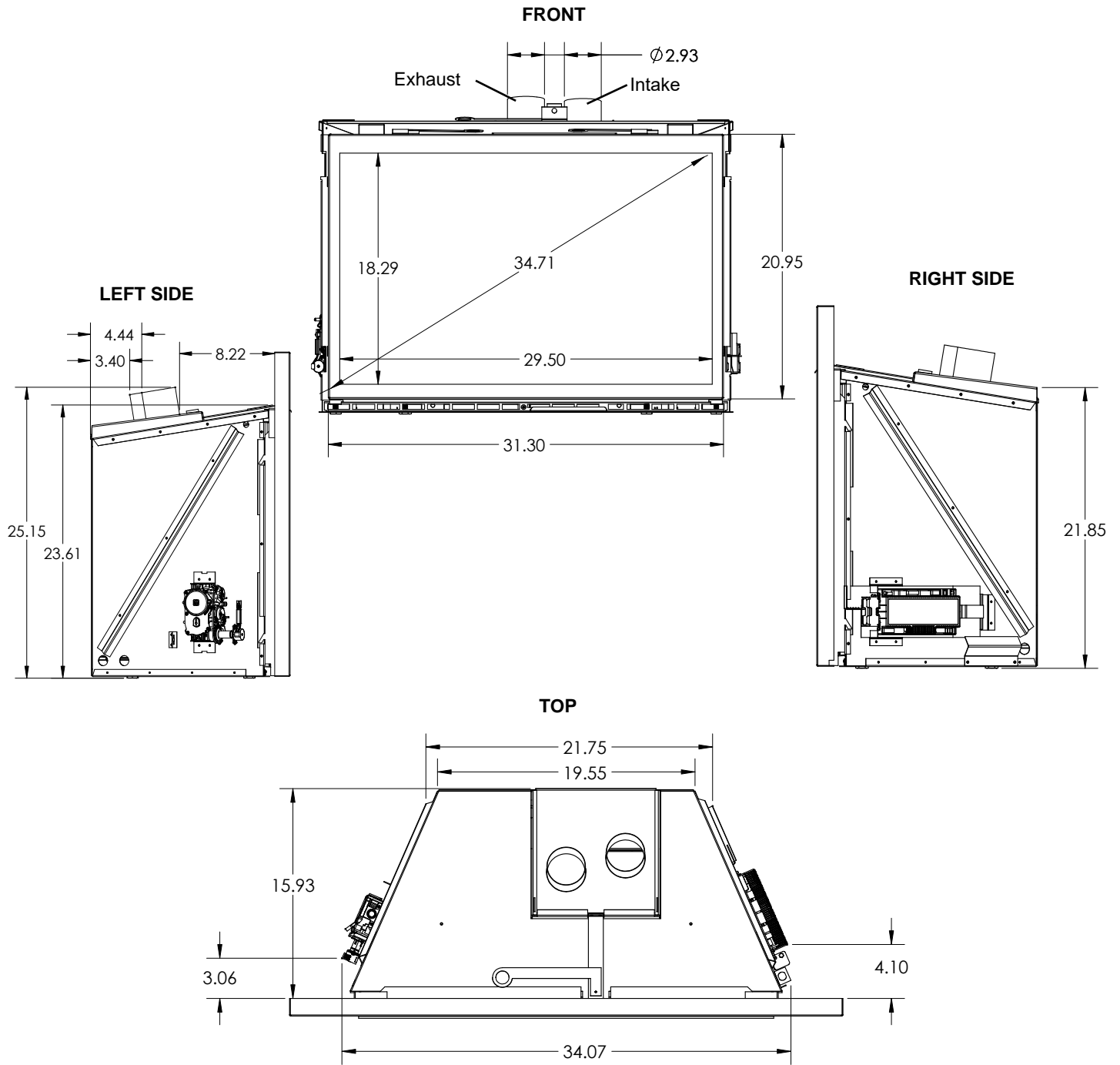

Metric Equivalents												
	Inches	mm	Inches	mm	Inches	mm	Inches	mm	Inches	mm	Inches	mm
Front	2.93	74.42	18.29	464.6	34.71	881.6	20.95	532.13	29.5	749.3	31.3	795.02
Top	21.75	552.45	19.55	496.6	15.93	404.6	3.06	77.72	4.1	104.14	34.07	865.38
Left Side	4.44	112.78	8.22	208.8	3.4	86.36	25.15	638.81	23.61	599.7		
Right Side	21.85	554.99										

9.0 Minimum Opening Dimensions

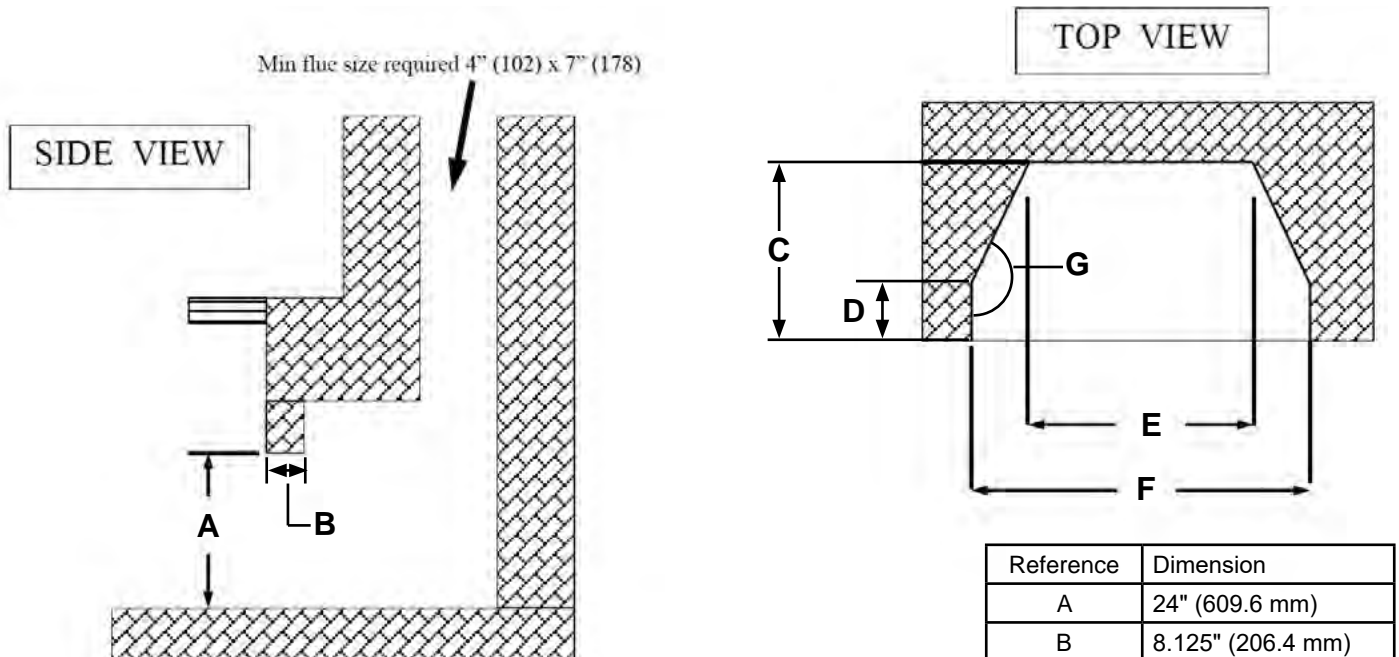

Figure 9.0.01:

Reference	Dimension
A	24" (609.6 mm)
B	8.125" (206.4 mm)
C	16" (406.4 mm)
D	3.32" (84.3 mm)
E	23.5" (596.9 mm)
F	34.625" (879.5 mm)
G	156.32°

WARNING: Failure to position the parts in accordance with these diagrams or failure to use only parts specifically approved with this appliance may result in property damage or personal injury.

The installer must mechanically attach the marking supplied with the gas fireplace insert to the inside of the firebox of the fireplace into which the gas fireplace insert is installed. See **Figure 9.0.02**.

WARNING:

This fireplace has been converted for use with a gas fireplace insert only and cannot be used for burning wood or solid fuels, unless all original parts have been replaced, and the fireplace reapproved by the authority having jurisdiction.

AVERTISSEMENT:

Ce foyer a ete converti pour utilisation avec un foyer au gaz encastrable et ne peut etre utiliser pour bruler du bois ou autres combustibles solides a moins que toutes les pieces d'origine ete remplacees et que le foyer ait ete approuve de nouveau par l'autorite competente.

303-0123

Figure 9.0.02:

Cutting of any sheet-metal parts of the fireplace, in which the gas fireplace insert is to be installed, is prohibited except as described in **Section 9.1**.

If the factory-built fireplace has no gas access hole(s) provided, an access hole of 1 1/2" (38.1 mm) or less may be drilled through the lower sides or bottom of the firebox in a proper workmanship-like manner. This access hole must be plugged with noncombustible insulation after the gas supply line has been installed.

The fireplace flue damper can be fully blocked open or removed for installation of the gas fireplace insert.

The fireplace and fireplace chimney must be clean and in good working order and constructed of noncombustible materials. The chimney clean-outs must fit properly.

Refractory, glass doors, screen rails, screen mesh and log grates can be removed from the fireplace before installing the gas fireplace insert.

Smoke shelves and baffles may be removed if attached by mechanical fasteners. Trim panels must not seal ventilation openings in the fireplace.

9.1 Factory Built Fireplaces

The following information applies to **Factory Built (metal) Wood-Burning Fireplace** installations:

Trim panels must not seal ventilation openings in the fireplace. Any parts that are removed must be saved and reinstalled if the insert is ever removed. If the factory-built fireplace has no gas access hole(s) provided, an access hole of 1 1/2" (38.1 mm) or less may be drilled through the lower sides or bottom of the firebox in a proper workmanship-like manner. This access hole must be plugged with noncombustible insulation after the gas supply line has been installed.

The damper (A) and grate with logset (B) must be removed or fully blocked open.

The smoke shelf (C), internal baffles (D), screen (E), masonry lining or refractory (G and I), and metal or glass doors (F) may be removed.

The fireplace must be permanently marked to indicate that it has been altered and is no longer suitable for burning any fuel unless the removed parts are reinstalled (See **Figure 9.0.02**). Cutting out of any metal parts is prohibited, except the metal floor (J) as specified.

The insulation (H), and any structured rigid frame member must not be removed or altered (side and top of door frame, side and top of the face of fireplace, metal sides, etc.).

The metal floor of the firebox may be removed only if the following is strictly adhered to.

The metal floor (J) may be removed to allow additional room for installation of the insert as long as it does not compromise the structural integrity of the existing fireplace and you maintain a mandatory minimum 1/4" clearance between the bottom of the insert and the bottom shell of the existing fireplace. This may be achieved by using strips of noncombustible material or by using leveling bolts on the insert (See **Figure 9.1.02**). If the floor is removed the insert must be placed directly on the metal base of the metal fireplace. **Under no circumstance can it be placed directly on a combustible material.**

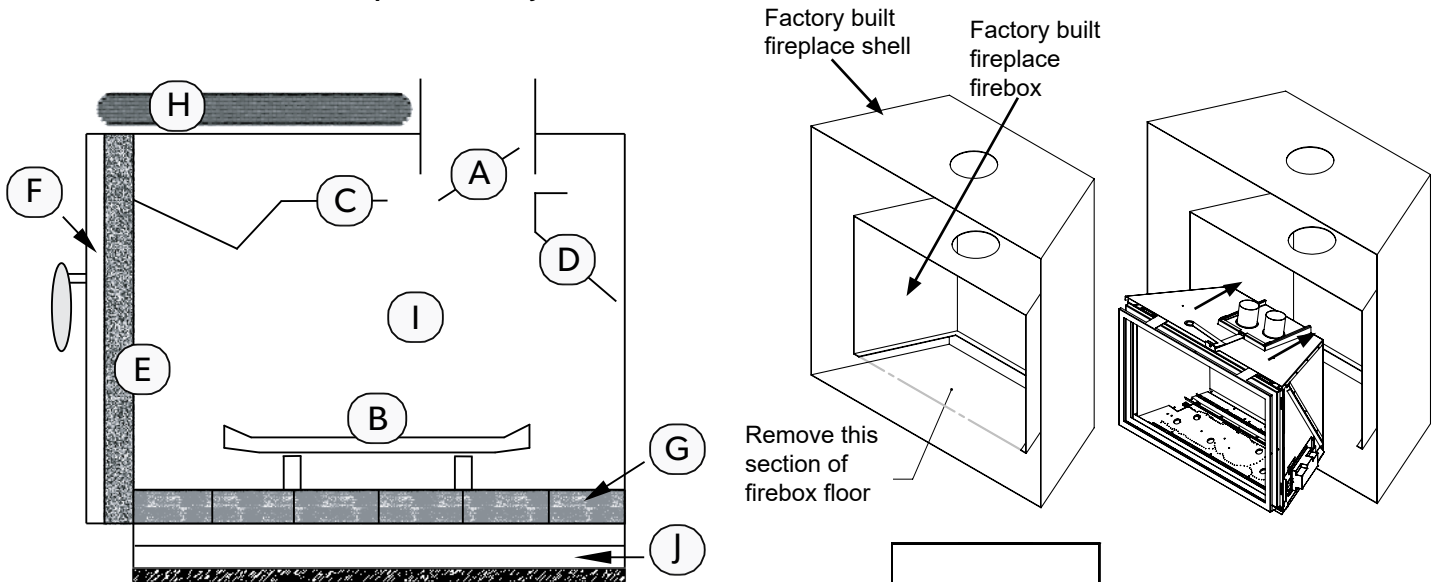

Figure 9.1.01: Side view of Factory Built (metal) Wood Burning Fireplace.

9.2 Refacing a Masonry Fireplace

Using Steel Studs and Cement Board on Wood Fireplaces

Brick or rock facing may be removed and replaced with noncombustible material such as steel studs and cement board.

WARNING: Only facing material may be removed. All other masonry material must not be cut out, chipped away, or removed.

WARNING: Louvers or any air circulation around existing solid fuel fireplace must not be blocked or covered.

The area between the masonry and the cement board must be sealed so that no heat can enter the open space between the masonry of the wood fireplace and the refacing material. **The insert must be moved outward so that the face of the fireplace is flush with the finishing material.**

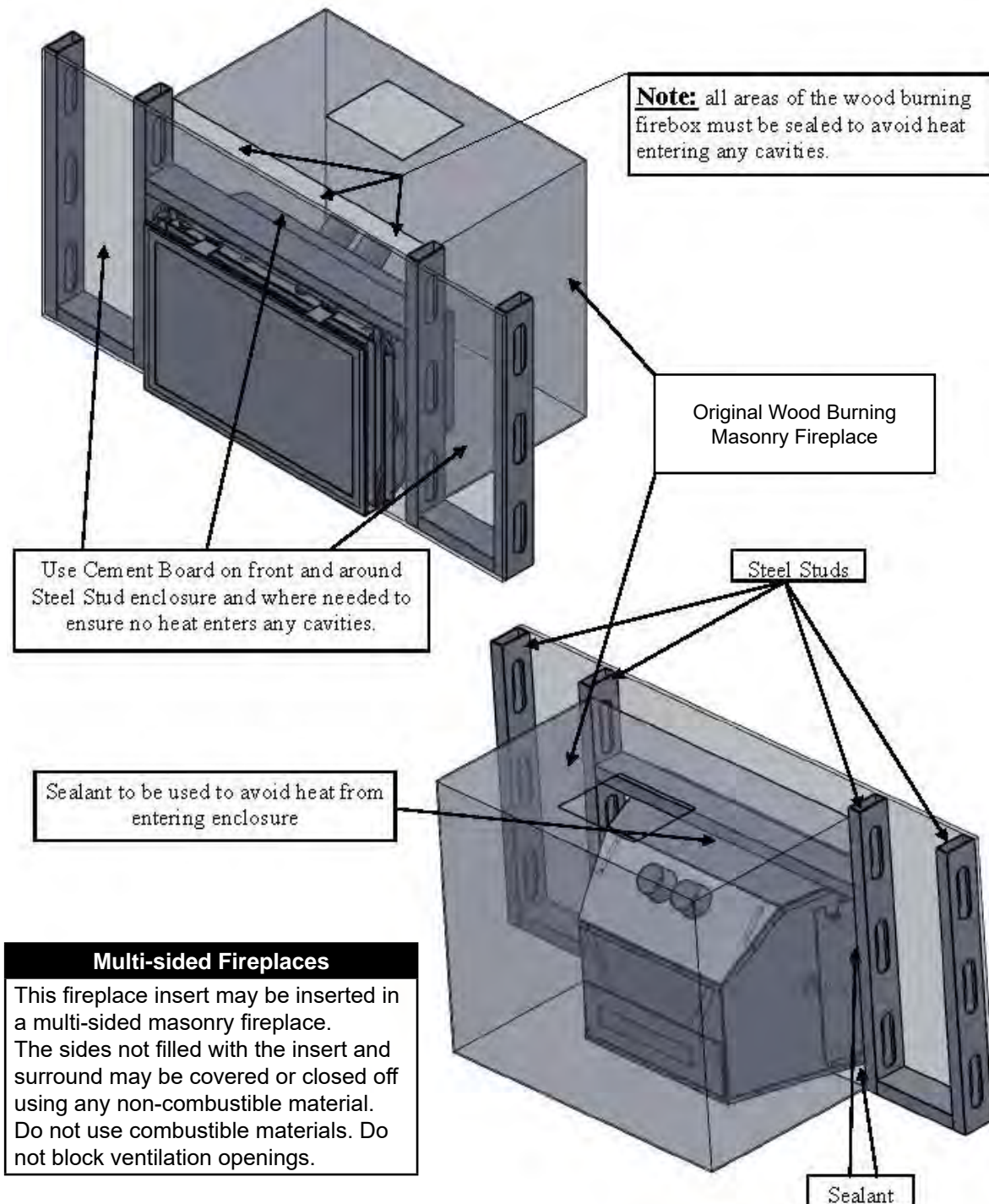

Figure 9.2.01:

10.0 Clearances to Combustibles

WARNING: Failure to position the parts in accordance with these diagrams or failure to use only parts specifically approved with this appliance may result in property damage or personal injury or loss of life.

CAUTION: This appliance is designed for use in any masonry or factory-built, wood-burning fireplace. It cannot be enclosed by combustible material and used as a factory built gas fireplace (zero clearance fireplace).

10.1 Mantel Clearances

Mantel clearances are measured from the top of the appliance door. Ensure combustible material is not placed within the area shown.

	Design Specialties Fronts	Archgard Surrounds (UA6000, UA6100, UA6200, UA6400)
A	18" (457mm)	9" (229mm)
B	20" (508mm)	11" (280mm)
C	22" (559mm)	13" (330mm)
D	24" (610mm)	15" (381mm)
E	26" (661mm)	17" (432mm)
F	28" (711mm)	19" (483mm)

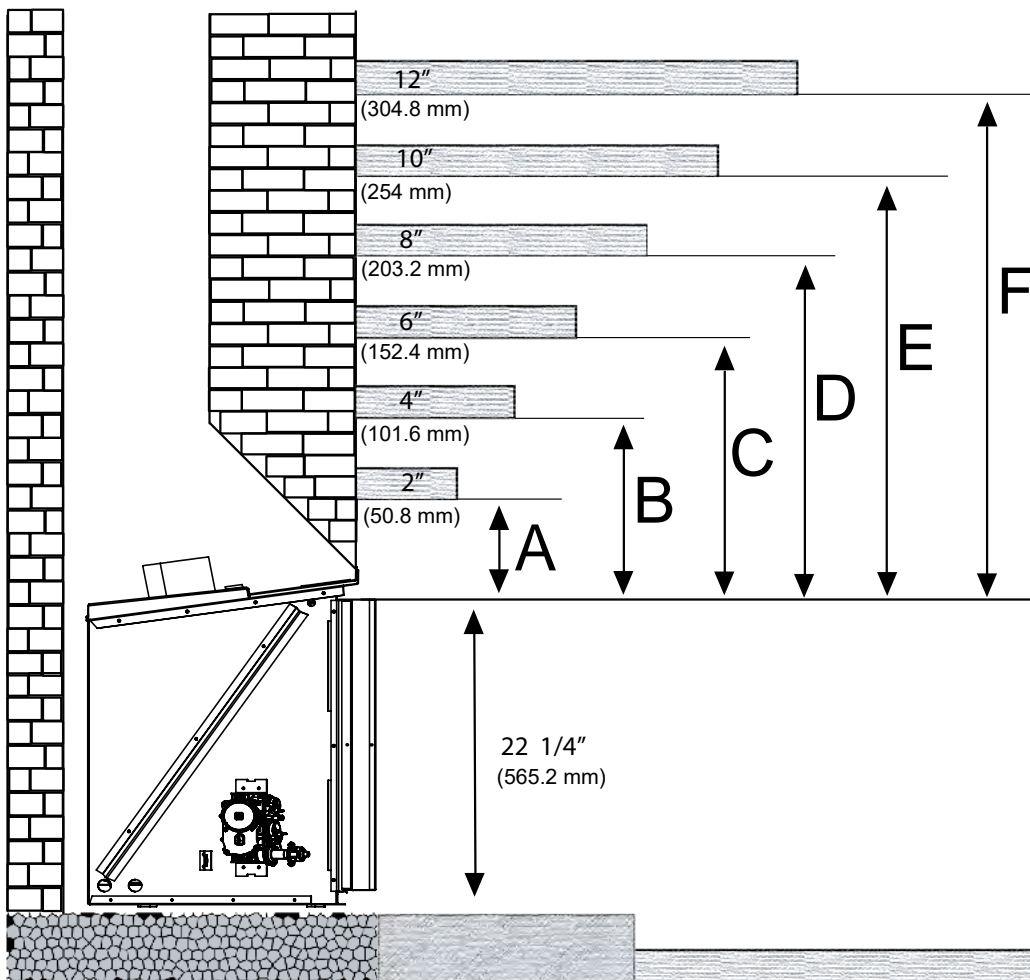

Figure 10.1.01

10.2 Sidewall Clearances

Maintain a minimum of 8" (203.2 mm) clearance from the side of the door to sidewalls or mantel supports.

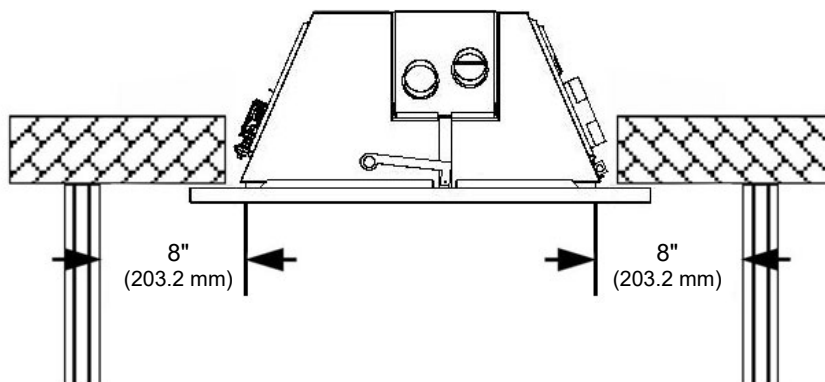

Figure 10.2.01

10.3 Hearth Clearances

WARNING

Failure to position the parts in accordance with these diagrams or failure to use only parts specifically approved with this appliance may result in property damage or personal injury.

Any hearth that extends outward in front of the insert must not have any combustible material closer than 3.5" (88.9 mm) to the bottom of the gas fireplace insert regardless of whether a noncombustible material covers the combustible material. This includes any type of framing underneath a noncombustible material such as tile, marble, or stone. Any material farther than 3.5" (88.9 mm) to the bottom or 16" from the front of the door of the gas fireplace insert can be combustible.

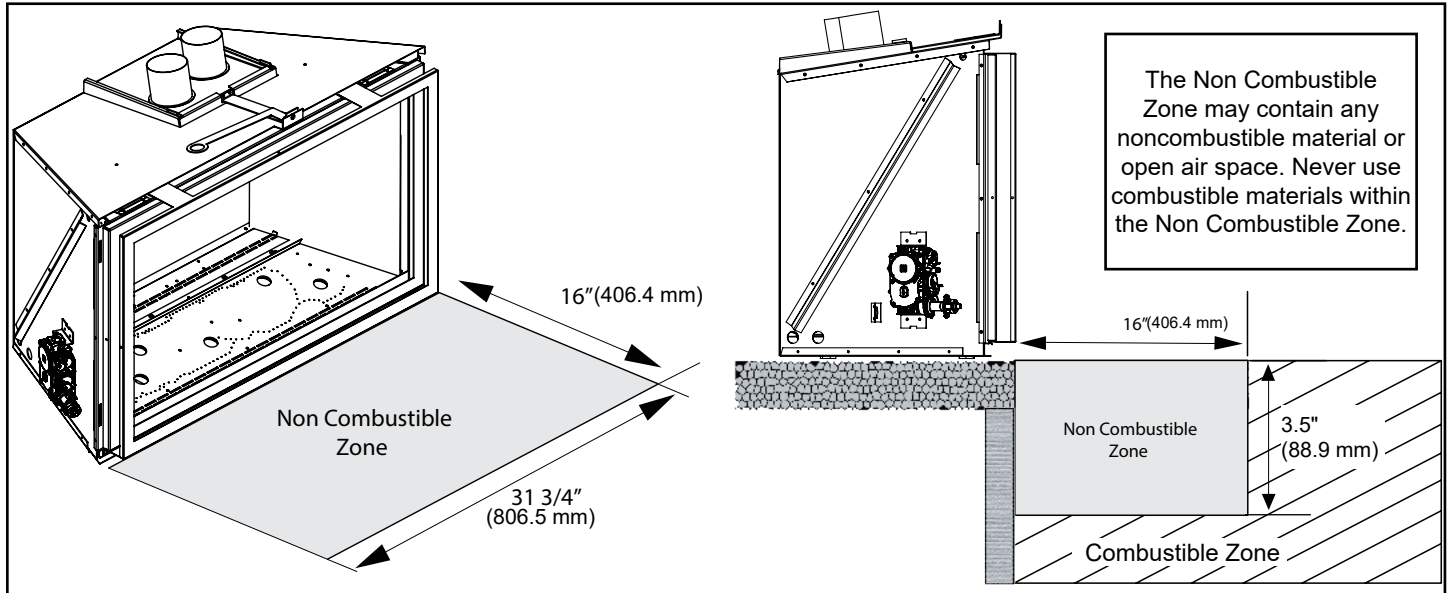

Figure 10.3.01

NOTE

All specified clearances must be maintained from the top surface of carpeting, tile, etc.

10.4 Hearth Protection

The insert may be installed closer to a combustible hearth if thermal protection is used. The thermal protection must be a non combustible material that has an R value that is equal to or greater than 1.4038.

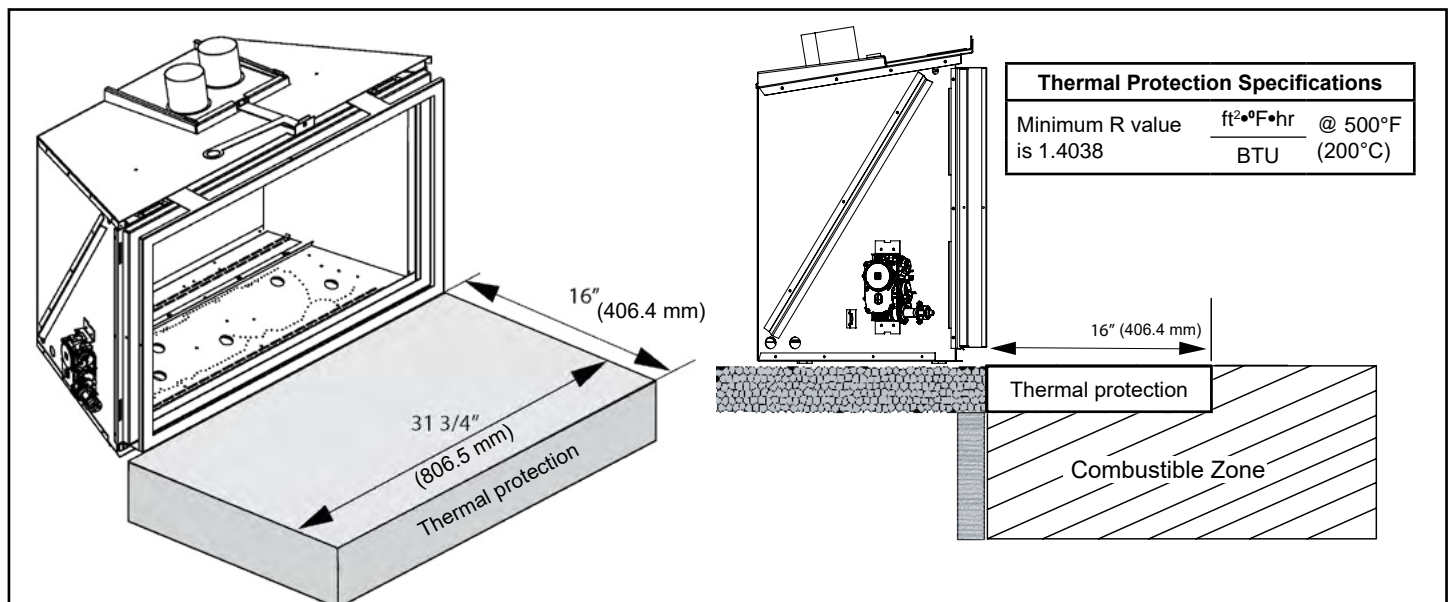

Figure 10.4.01

10.5 Heat Sensitive Flooring Materials

Ambiance fireplaces are heating products, designed to produce a large amount of radiant and convective heat. The clearances specified above are intended to be minimum clearance distances to combustible materials, however, flooring directly adjacent to the minimum hearth clearances may reach temperatures of up to 180°F (82°C) or higher depending on the installation.

Please check with your flooring manufacturer for temperature tolerances as some materials, such as vinyl, tend to be more sensitive to temperatures above average room temperature and may be damaged or warped if exposed to heat.

We recommend testing any flooring material to ensure that it can withstand temperatures generated by this fireplace. If the tolerances of the flooring material are not known or are not capable of withstanding the temperatures generated by this fireplace, install a heat pad constructed of material that is not sensitive to heat, or adjust clearances to heat sensitive materials as shown below.

Note: clearances shown are the width of the fireplace door. The dimensions shown are guidelines only and cannot account for all flooring material. The dimensions shown do not replace the hearth clearances for this product. Always maintain the clearances to combustible materials as shown on the previous page.

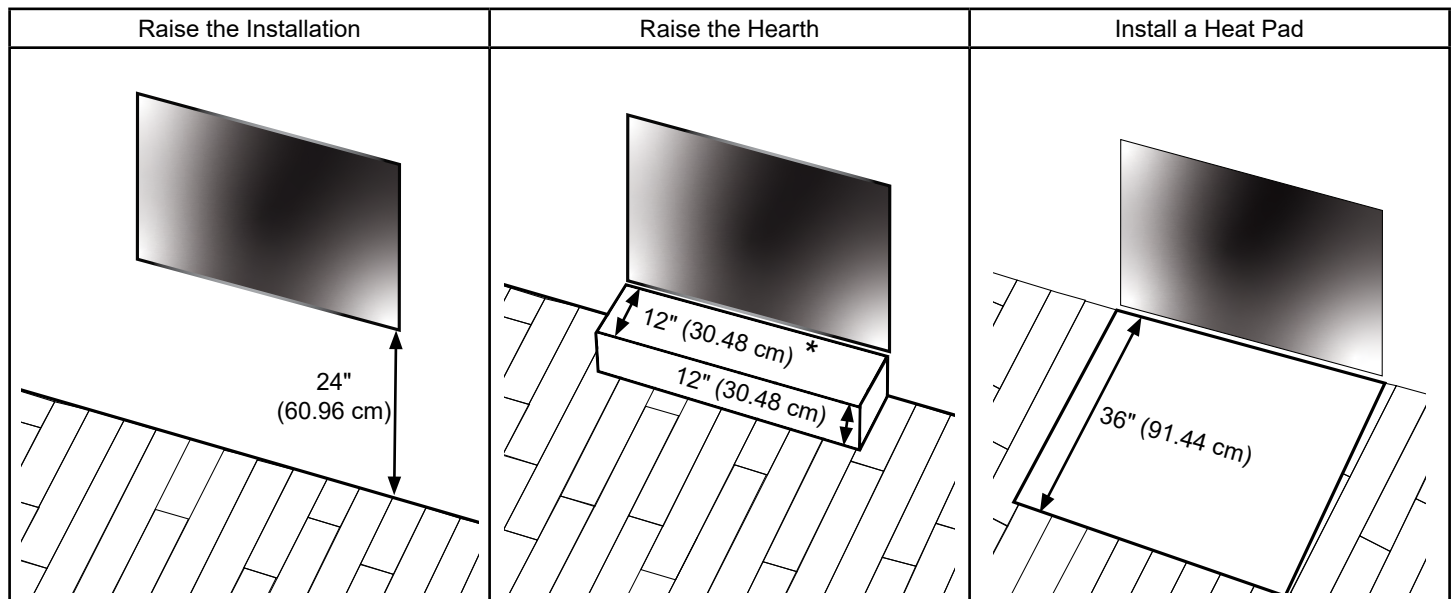

Figure 10.5.01

* Use whichever distance is greater when compared to the hearth clearances.

11.0 Gas Connections

Before connecting the appliance to the gas supply line, double check that the appliance you have purchased is designed for the gas type you are using. The gas type markings are located on the rating plate (See **Section 4** and **Section 6**) and also on the appliance's gas valve.

Adequate clearance for proper installation and checking of the gas connections must be provided. **All gas connections must be checked for gas leaks.**

Have your gas supplier or a qualified gas fitter run a gas supply line into the solid fuel fireplace. The line must be properly sized and fitted according to the installation codes. Immediately upstream of the supply connection, the fitter shall provide an accessible manual shut-off valve. When connecting the supply line to the gas valve, the installer shall brace the gas valve to ensure that the gas valve is not moved from its bracket. If the valve is not braced when the supply line is connected, the valve may be moved and cause a "break" in the main burner supply line. Such damage is not covered by the manufacturer's warranty.

CAUTION: The appliance and its individual shut-off valve must be disconnected from the gas supply piping system during any pressure-testing of that system at test pressures in excess of 1/2 psig (3.5 kPa). The appliance must be isolated from the gas supply piping system by closing its individual manual shut-off valve during any pressure-testing of the gas supply piping system at test pressures equal to or less than 1/2 psig (3.5 kPa). Failure to do so will damage the appliance's gas valve. Such damage is not covered by the manufacturer's warranty.

Natural Gas Pressure Settings:

The inlet supply or line pressure must be a minimum of 5.0" W.C. (1.2 kPa) and a maximum of 14.0" W.C. (3.5 kPa). The orifice is a #31 DMS (3.05 mm) drill size.

ELEVATION	INPUT RATING
0-4500 ft (0-1372 M)	40,000 BTU/hr (11.72 kW)
4500 ft (1372 M) and above.	40,000 BTU/hr (11.72 kW) less 4% per 1000 ft. (305 M) above sea level.

Please contact your local distributor for the appropriate orifice size you require.

Propane Pressure Settings:

The inlet supply or line pressure must be a minimum of 12.0" W.C. (2.7 kPa) and a maximum of 14.0" W.C. (3.5 kPa). The orifice is a #47 DMS (1.99 mm) drill size.

ELEVATION	INPUT RATING
0-4500 ft. (0-1372 M)	40,000 BTU/hr (11.72 kW)
4500 ft. (1372 M) and above.	40,000 BTU/hr (11.72 kW) less 4% per 1000 ft. (305 M)

Please contact your local distributor for the appropriate orifice size you require.

11.1 Clocking Procedure

IMPORTANT: THE INPUT RATING SHOULD ALWAYS BE CHECKED WHEN FIRST FIRING THIS APPLIANCE.

Before you begin, shut off all other gas appliances including any standing pilots. Light the fireplace and wait 15 minutes. Clock the time to burn 1ft³ of gas on the meter. Check with your gas supplier for the gas BTU content at your elevation. Input is the rate of flow multiplied by the heating value of the gas (cubic feet/hour x BTU per cubic feet). Note: This assumes a dry gas meter at 1/2 psi. If using a 2 psi dry gas meter the unit will rate lower as the calculation has to correct for the higher pressure in the meter. If the unit is over-rated, contact your authorized Ambiance dealer. The following calculation equation gives a rough estimation as it does not correct for temperature and pressure.

Rough Calculation Equation:

$$\frac{3600}{\text{time to burn 1ft}^3 \text{ gas in seconds}} \times \frac{\text{gas caloric value in BTU/ft}^3}{\text{Rating in BTU/hr}} = \text{Rating in BTU/hr}$$

12.0 Conversion Kit Instructions

IMPORTANT: This fireplace is Natural gas ready. If converting to LP gas, follow instructions below.

WARNING: This conversion kit shall be installed by a qualified service agency in accordance with the manufacturers instructions and all applicable codes and requirements of the authority having jurisdiction. If the information in these instructions is not followed exactly, a fire, explosion or production of carbon monoxide may result, causing property damage, personal injury or loss of life. The qualified service agency is responsible for proper installation of this kit. The installation is not proper and complete until operation of the converted appliance is checked as specified in the instructions supplied with the kit. Refer to appliance owner's manual or product data plate for proper inlet and manifold pressure adjustments and orifice sizing.

IMPORTANT: For high altitude installations above 4500 ft (1372 meters), consult local gas distributor or the authority having jurisdiction for proper derating methods.

KIT NUMBERS: UA1400 for LP gas and UA1500 for Natural Gas

KIT INCLUDES:

- Gas conversion label (303-0128)
- Burner orifice (part number 301-0068-47, #47 DMS for LPG) (part number 301-0068-31, #31 DMS for NG)
- Instruction Sheet
- SIT 885 Valve conversion kit c/w instructions & gas type label

**WARNING: SHUT OFF GAS SUPPLY AND ELECTRICAL POWER TO FIREPLACE
SHUT OFF GAS SUPPLY BEFORE DISCONNECTING ELECTRICAL POWER**

12.1 Prepare the Fireplace

Remove the surround, barrier screen, glass frame assembly, logs or glass media, embers and brick panels or firebox liner (if applicable)*.

Remove the burner*.

*See relevant sections in this manual.

Remove the burner orifice using a 1/2" wrench. Replace with the orifice supplied with the conversion kit. Use a small amount of pipe sealant on the threads of the orifice mount. Do not use too much as it can block the orifice.



Figure 12.1.01:

12.2 Pilot Conversion

Using a 7/16" wrench and loosen the pilot hood 1/4 turn. Slide the tab at the bottom of the orifice hood all the way so the red side (propane) with the hole in it is showing. Tighten the pilot hood back up so that it is lined up with the two probes on both sides of the pilot assembly.

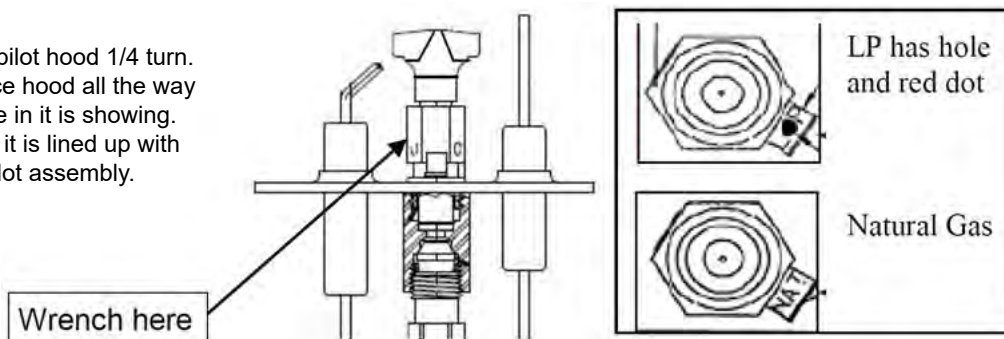

Figure 12.2.01:

12.3 Convert the Gas Valve

WARNING: Installation of this conversion kit must only be undertaken by a qualified and certified gas appliance installer.

Verify that the following items are present in the package:

- Pressure regulator assembly (E)
- Two (2) screws (F)
- Identification label (G)
- Installation instructions (this document)

1. Shut off the gas supply to the valve and shut down the electric supply.
2. See **Figure 12.3.01**. Using a Torx T20, or slotted screwdriver, remove and discard the two (2) pressure regulator mounting screws (A), pressure regulator tower (B), and the spring and diaphragm assembly (C), (if applicable).
3. Ensure the rubber gasket (D), which is prefitted as part of assembly (E), is properly positioned, see **Figure 12.3.02**, otherwise fit the gasket as shown **Figure 12.3.02**.
4. Install the new STEPPER MOTOR pressure regulator assembly, as shown in **Figure 12.3.03** and **Figure 12.3.04**. Use the supplied screws (F), M4 x 0.7 threaded, length of thread $L = (16 \text{ mm} + 0 - 0.5 \text{ mm})$, steel material, resistance class 8.8 (see **Figure 12.3.05**).
5. Manually thread the two conversion kit mounting screws into the valve body. Use a standard screwdriver or T20 Torx bit and tighten to the screws with a fixing torque of $25 \text{ lb-in} \pm 5\%$.
IN THE EVENT THAT THE THREADS OF THE VALVE ARE STRIPPED OR DAMAGED, REPLACE THE VALVE.
6. Install the enclosed identification label (G) to the valve body where it can be easily seen.
7. Make STEPPER MOTOR and valve electrical connections, apply gas to system and relight appliance according to manufacturers instructions.
8. With the main burner "ON", test the new pressure regulator assembly for leaks using a soap solution.
9. Relight the main burner and verify proper burner ignition and operation.

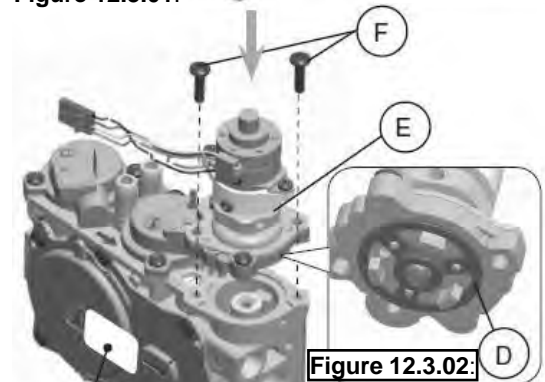
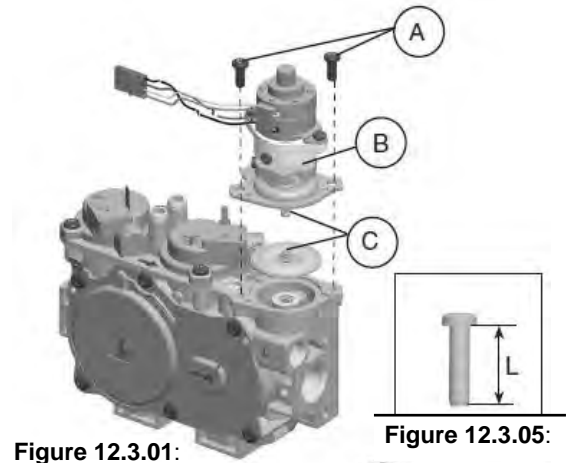

WARNING: Installation should be carried out in a clean environment.

WARNING: This modulating conversion kit must ONLY be applied as part of a conversion kit supplied by the APPLIANCE MANUFACTURER.

WARNING: Correct operation of the system cannot be guaranteed if the conversion kit or valve has been dropped or has sustained a strong impact.

INSTALLER NOTICE: These instructions must be left with appliance.

12.4 Complete the Conversion

- Reinstall the burner, brick liners or firebox liner, logs or glass media, embers, and glass door*
- Turn on the gas and electrical supplies
- Turn on the fireplace so the burner is on
- Check for leaks at **all** connections

Test inlet and outlet pressure (See **Section 3.3**). Visually check pilot flame. Flame should envelope top of the flame sensor and extend forward onto the burner. To adjust pilot turn the pilot adjustment screw on the control valve clockwise to decrease or counter clockwise to increase pilot flame. Clock the rating as shown in **Section 11.1**. Adjust the primary air according to specifications in this manual or as found on the rating plate.

- Turn fireplace off
- Affix gas type label to the rating plate label (See **Section 6.1** for rating plate location)
- Complete the conversion label and affix to valve assembly plate
- Reinstall the barrier screen and surround*

*See relevant sections in this manual.

13.0 Venting Instructions

WARNING: Operation of this heater when not connected to a properly installed and maintained venting system can result in carbon monoxide (CO) poisoning and possible death. The appliance must not be connected to a chimney flue serving a separate solid fuel burning appliance.

CAUTION

Only approved 3" (76mm) double wall aluminum or stainless flex liners and approved vent terminals are to be used for this appliance.

This appliance is designed for dual 3" (76 mm) double wall aluminum flex liner. The liner must run the entire length of the chimney from the appliance to the termination.

The flue length must be a minimum of 10' (3.05 M) and a maximum of 40' (12.2 M) from the top of the gas fireplace insert.

Masonry chimneys may take various contours which the flexible liner will accommodate, however, keep the flexible liner as straight as possible, avoiding unnecessary bending but at all times keep a minimum of 3" (76 mm) inside bend radius.

The Air Intake Flex Liner must be connected to the inlet air collars of the termination cap and the appliance.

The Exhaust Flex Liner must be connected to the exhaust collars of the termination cap and the appliance.

The Air intake and Exhaust connections are marked on the gas appliance. See Figure 13.1.01.

DO NOT REVERSE THESE CONNECTIONS

CAUTION

To ensure that the venting is not accidentally obstructed or punctured, the damper of the host fireplace must be permanently disabled by either complete removal of the damper, or by being fully blocked open, for the installation of a gas fireplace insert.

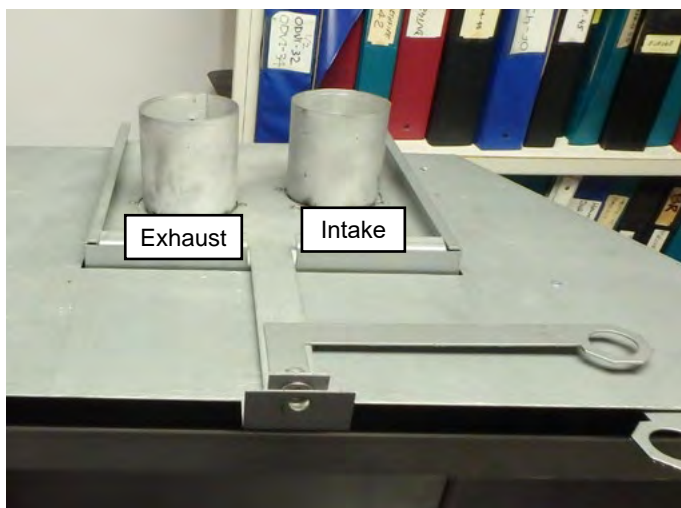

Figure 13.1.01: Intake & Exhaust as viewed from back of fireplace.

13.1 Approved Terminations

Archgard Venting Components	
Vent Component	Part Number
Vertical Termination	999-INS-TK
3" x 30' Aluminum Flex Liner	999-INS-FL330
3" x 50' Aluminum Flex Liner	999-INS-FL350
Approved venting components from third party manufacturers may be found on the following page.	

Third Party Venting Components					
	BDM	Selkirk	Duravent	ICC	Amerivent
3" Flex (10ft)	95270310	AFE10-03	N/A	N/A	3ALKE10
3" Flex (25ft)	95270325	AF3-25L	3DFA-25	N/A	1730250
3" Flex (30ft)	95270330	N/A	N/A	N/A	N/A
3" Flex (35ft)	95270335	AF3-35L	3DFA-35	TC-3AL35	1730350
3" Flex (50ft)	95270350	AF3-50L	N/A	TC-3AL50	3ALKE50
3" Flex Coupling	95090390	AF3-FC	3DFA-FC	TM-CFAA3	Comes with
4x6 5/8 Coaxial High Wind Cap	DVR6-VCH	4DT-VC	46DVA-VCH	TM-4SVT	N/A
4x6 5/8 Coaxial Low-Profile Cap	DVR6-LPC	4DT-VT	N/A	N/A	4DVC
3x3 Colinear to 4x6 5/8 Coaxial Adapter	DVF33-A6	4DT-CBT, 4DT-AAC	46DVA-GK or 46DVA-CLTA	TM-CTA	4DCAT33
High Wind Shield Round	DVR68-VWG	N/A	46DVA-VWG	TM-SVTS	N/A
High Wind Shield Rectangular	N/A	N/A	N/A	TM-CTS	N/A
Co-linear High Wind Vert Term Kit (with 35 ft. Flex) for Masonry Chimney	94203370HWS	1604645	46DVA-CL33	TM-ALK33	DVIK33 (Not High Wind)
Co-linear Rectangular Vent Term Kit (with 35 ft. Flex) for Masonry Chimney	N/A	N/A	N/A	TM-ALT33	N/A
Co-linear Direct Vent Factory Built Reline Kit High Wind Vert Term (with 35ft Flex)	N/A	N/A	46DVA-CL33KFB	TC-AL35, TM-IVT, TM-IVTP	N/A
3x3 Co-linear Round Vert Term	940033HWS	1604643	N/A	TM-IVT	DVCC33
3x3 Co-linear High Wind Vert Term Round Base	9400332RD	N/A	N/A	TM-IVT, TM-IVTP	N/A
3x3 Co-linear High Wind Vert Term Square Base	940033HWS	N/A	N/A	TM-IVT, TF-MFR, TF-MFC, TF-MF	N/A
Co-linear Masonry Flashing Rectangular Vert Term	N/A	N/A	N/A	TF-CTF, TF-CTFC	N/A
3x3 Co-linear Square Vert Term	940033, 9400330808SS	N/A	N/A	N/A	N/A
3x3 Co-linear Rectangular Vert Term	940034EC26SS	N/A	N/A	TM-CT3	N/A
Co-linear Masonry Flashing Rectangular Vert Term	N/A	N/A	N/A	TF-CTF, TF-CTFC	N/A
Prefab Chimney Flashing	N/A	N/A	N/A	TM-IVTP	N/A
3" Appliance Co-linear Flex Connector	N/A	4DT-CFC	46DVA-ADF	N/A	N/A
3x3 Co-linear Square Double Cap	940033DBL	N/A	N/A	N/A	N/A

ATTENTION

NO OTHER VENTING SYSTEM OR COMPONENTS MAY BE USED.

Part numbers shown are correct at the time of printing and should be confirmed with the manufacturer prior to purchase.
Follow manufacturer instructions for installation of termination.

13.2 Vent Slider Installation

To connect the vent slider to venting, follow the steps below.

Note: Photos show the appliance in an open room for clarity. These tasks will be completed within the existing masonry fireplace or factory-built wood burning fireplace.

Step 1: Unscrew the retaining screw and remove the vent slider from the appliance. Take care to avoid damage to the gasket under the vent slider when removing.

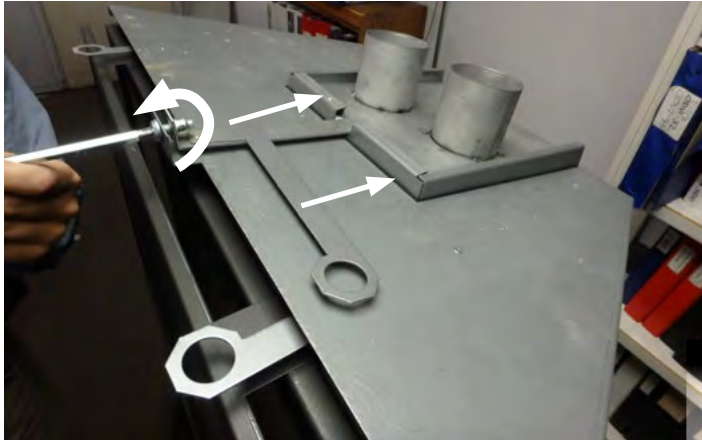

Figure 13.2.01:

Step 3: Align the vent slider with venting attached with the bracket.



Figure 13.2.03:

Step 5: Insert the screw that was removed in Step 1. Be sure to fully insert the screw until metal surfaces meet.

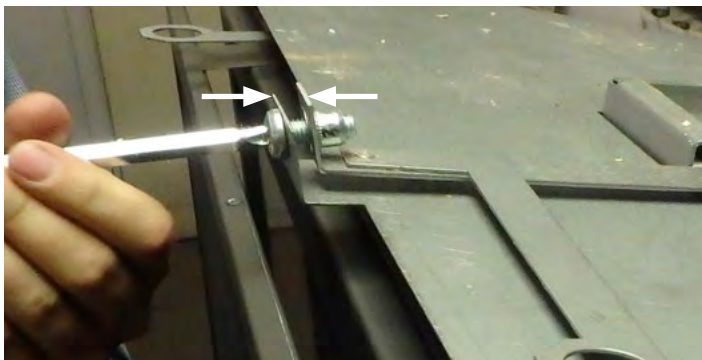

Figure 13.2.05:

Step 2: Connect the venting to the vent slider using screws and serpentine clamps.

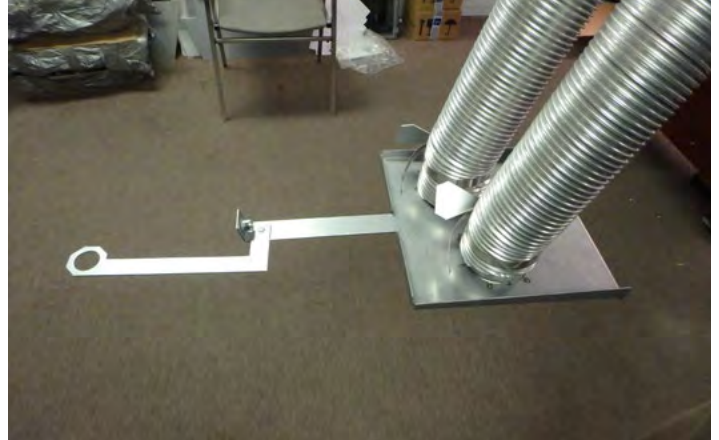

Figure 13.2.02:

Step 4: Slide the vent slider forward until it rests in the retaining bracket. Slowly pull the slider forward when installing to avoid damage to the gasket.

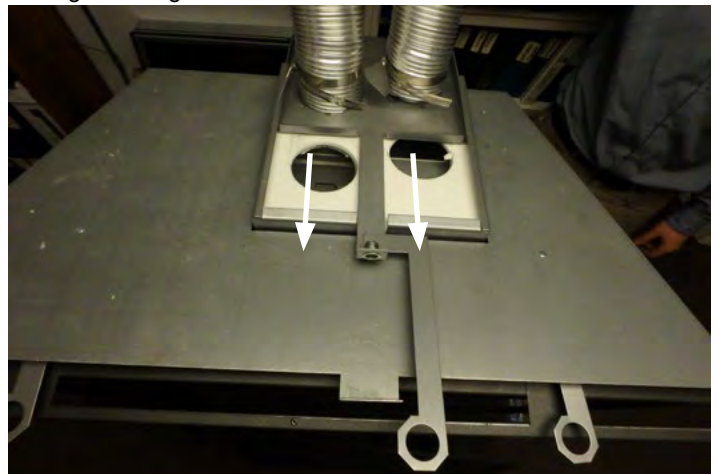

Figure 13.2.04:

WARNING

If the vent slider is ever removed after initial installation, the gasket **MUST** be replaced. Failure to replace the gasket could cause improper operation, damage to the appliance, injury, or even death.

13.3 Min/Max Vent Run

Instructions for installing venting and terminations (see list for approved venting and terminations).

Install the termination cap being sure to provide sufficient space (around and on top) so you do not impede the flow of air, both into and out of the cap. This cap is only to be used for non combustible installations. Do not recess into the top of the chimney.

1. Mark each end of one flex liner with "Air Intake".
2. Mark each end of the second flex liner with "Exhaust".
3. Pull the liner through the chimney.
4. Install the flashing.
5. Seal and attach the flex liner marked "Air Intake" to the vent terminal pipe marked "Air Intake" as per terminal manufacturers instruction. **DO NOT USE SILICONE.**
6. Seal and attach the flex liner marked "Exhaust" to the vent terminal pipe marked "Exhaust" as per terminal manufacturers instruction. **DO NOT USE SILICONE.**
7. Seal and attach the end of the flex liner marked "Air Intake" to the collar marked "Air Intake" on the appliance with the collar clamp provided with the unit. **DO NOT USE SILICONE.**
8. Seal and attach the end of the flex liner marked "Exhaust" to the collar marked "Exhaust" on the appliance with the collar clamp provided with the unit. **DO NOT USE SILICONE.**
9. Caulk all joints using a high temperature sealant such as milpac. **DO NOT USE SILICONE. Use of silicone sealants voids the warranty of the pilot assembly.**

NOTE: The flex liners must form a complete connection from the appliance flue collars to the vertical termination cap.

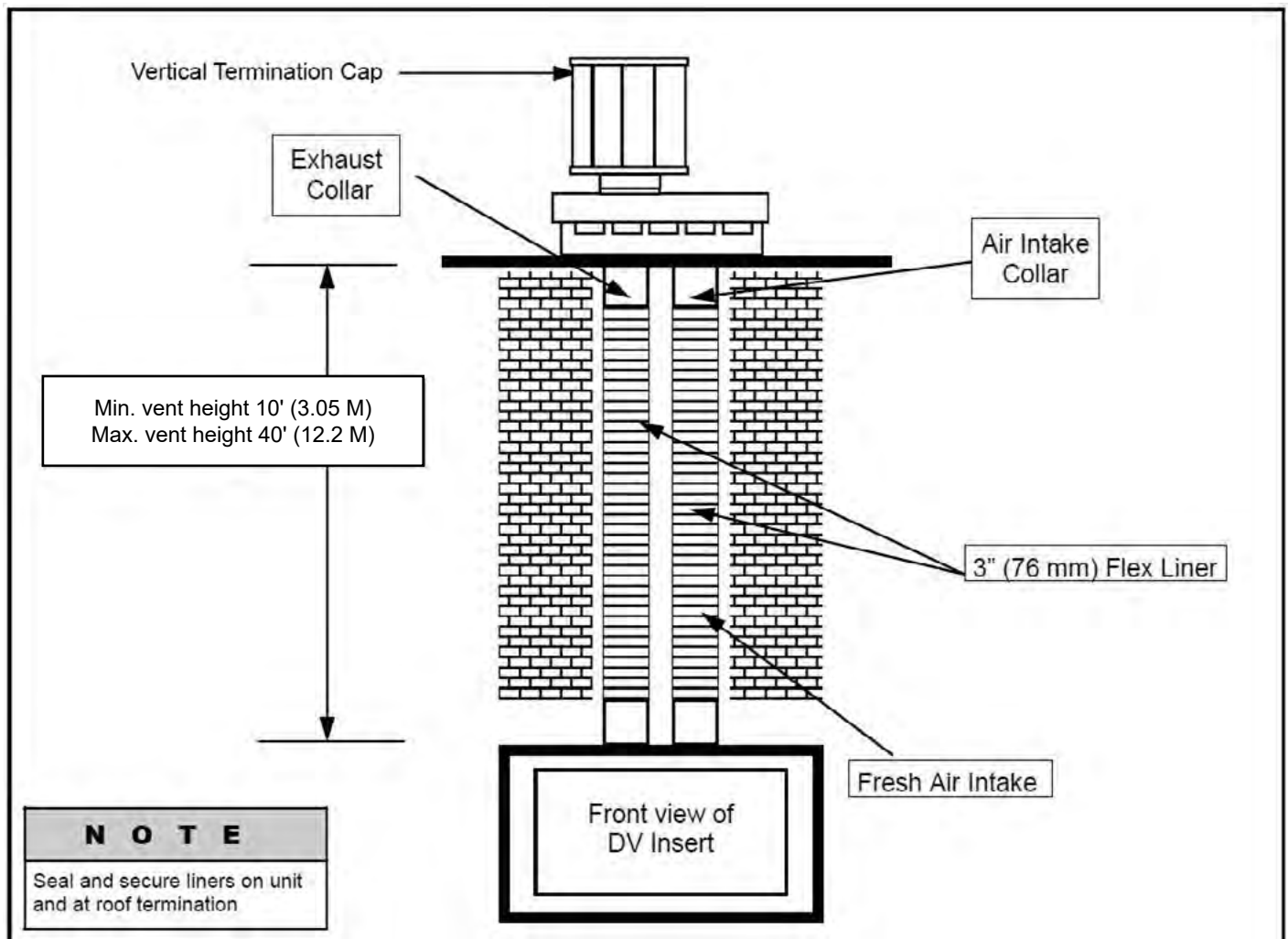

The minimum flue (chimney) size required to run the two 3" (76 mm) is 4" x 7" (100 mm x 178 mm).

Figure 13.3.01:

13.4 Using a Co-linear to Coaxial Adapter

The gas fireplace can be converted from co-linear to coaxial when it is desired to remove a section of the masonry fireplace chimney to below the roof line.

WARNING

This appliance must be installed by a qualified gas appliance installer. The installation must conform with the local codes or, in the absence of local codes, with the current National Fuel Gas Code ANSI Z223.1/ NFPA 54 in the US, or Installation Code CAN/ CGA-B149.1 in Canada. Electrical connections and grounding must conform with local code, or current National Electrical code ANSI/NFPA No. 70-1987 in the US, and in Canada the current Canadian Electrical Code CSA C22.1.

- The sections of coaxial pipe cannot be longer than 6ft. or 50% of the total vent length, whichever is shorter
- A sealed flashing must be placed on top of the chimney where the co-linear to coaxial adapter is seated
- The total vent run must be a minimum of 10ft. from the top of the gas fireplace insert
- A 1" clearance must be maintained from the coaxial pipe to insulation and combustible material
- The termination must be 18" from the roof to the bottom of the termination

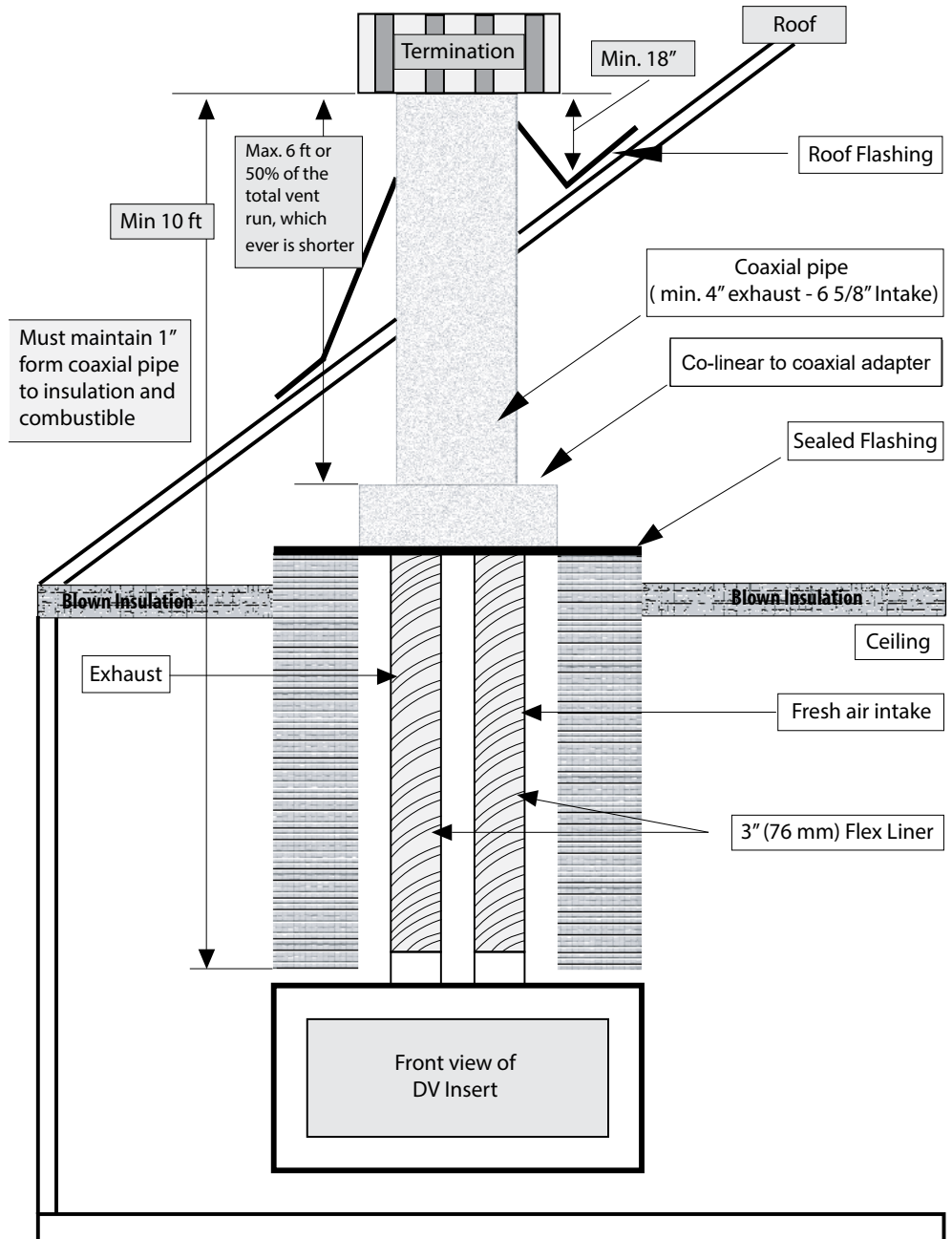

Figure 13.4.01:

14.0 Barrier Screen Installation

WARNING

NEVER OPERATE THIS APPLIANCE WITHOUT THE BARRIER SCREEN INSTALLED.

If barrier becomes damaged, the barrier shall be replaced with the manufacturer's barrier for this appliance (P/N: URP-891-0200).

Step 1: Align the hooks on the top of the screen with the openings in the door.

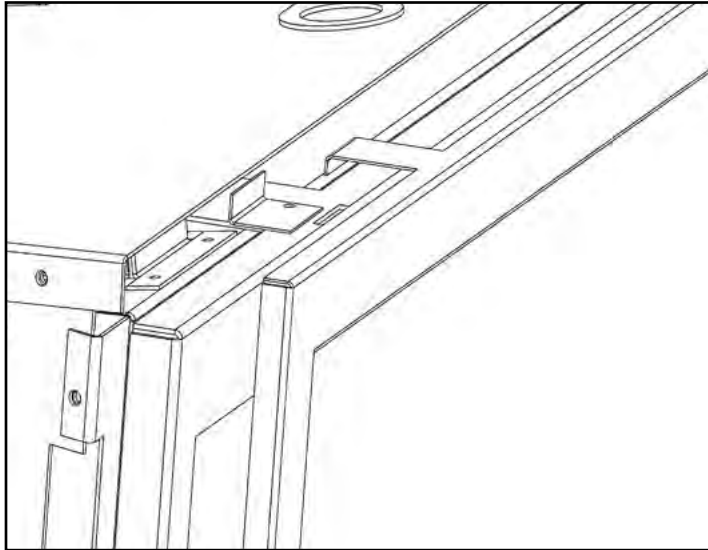

Figure 14.0.01:

Step 2: Align the hooks on the bottom of the screen with the bottom of the screen frame. The hooks will slide between the bottom of the frame and the glass.

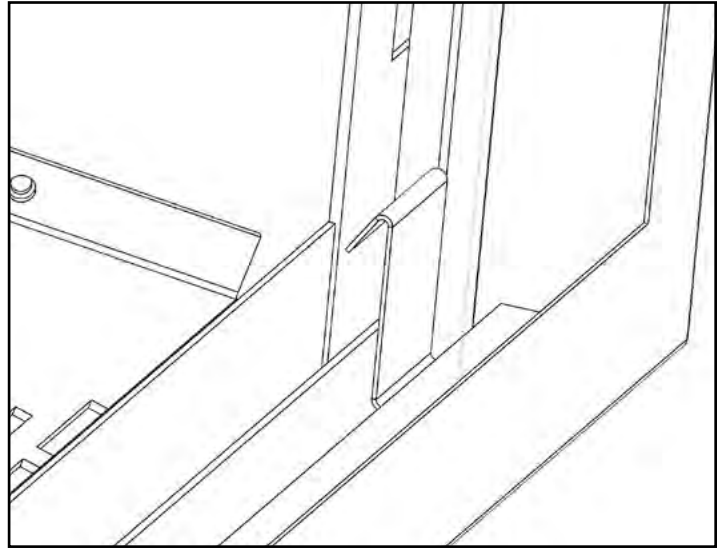

Figure 14.0.02:

Step 3: Drop the screen in place, ensuring all hooks engage on the top and bottom of the door.

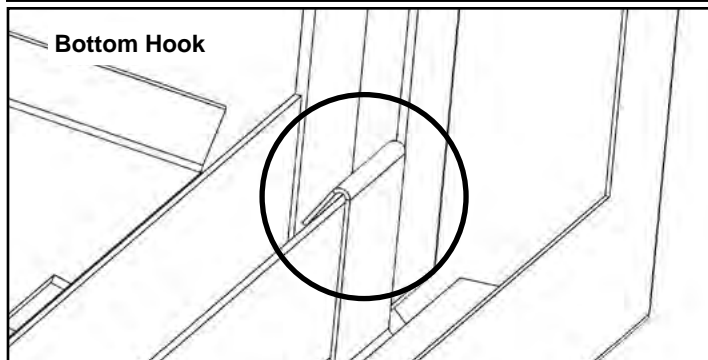
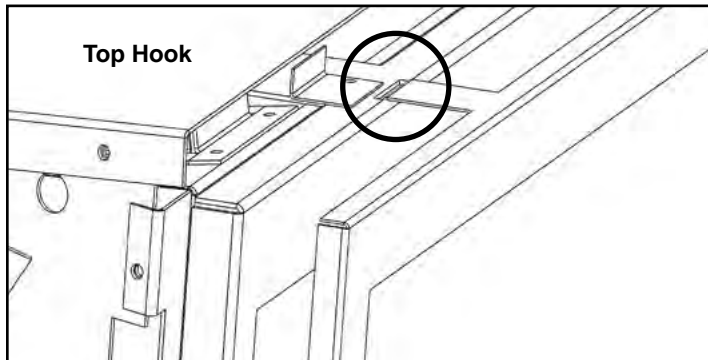

Figure 14.0.03:

Step 4: Swing the two screen retainer tabs so that they secure the top screen hooks in place.

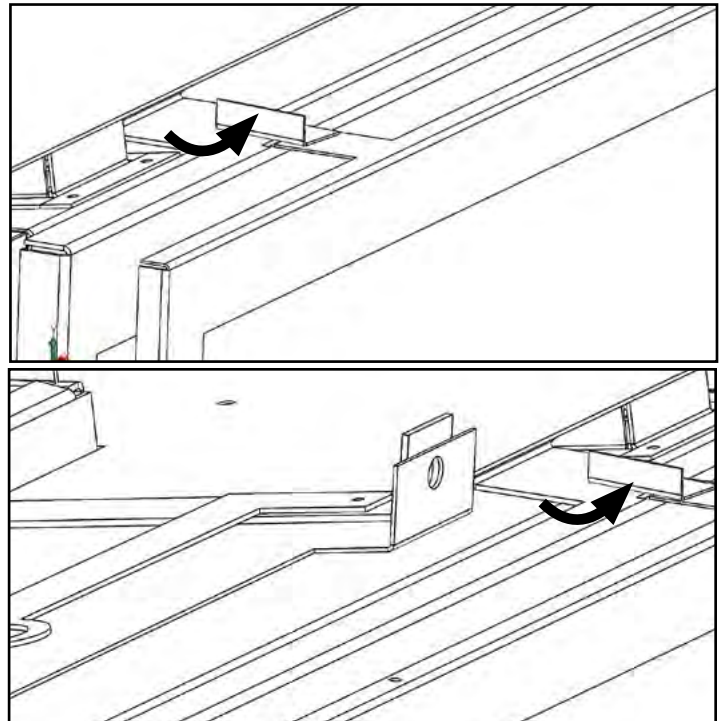

Figure 14.0.04:

15.0 Glass Door Installation

WARNING: Do not operate appliance with the glass front cracked or broken. Replacement of the glass should be done by a licensed or qualified service person. Do not attempt to remove the glass door when the appliance is hot. Be sure there are no fingerprints left on the glass panels during install or when cleaning as high temperatures can bake these prints on permanently. Inspect the door gasket to ensure no damage has occurred when installing the door.

Step 1: Hold the glass door at an angle so that the edge on the bottom of the door engages with the lower spring relief. See **Figure 15.0.01**.

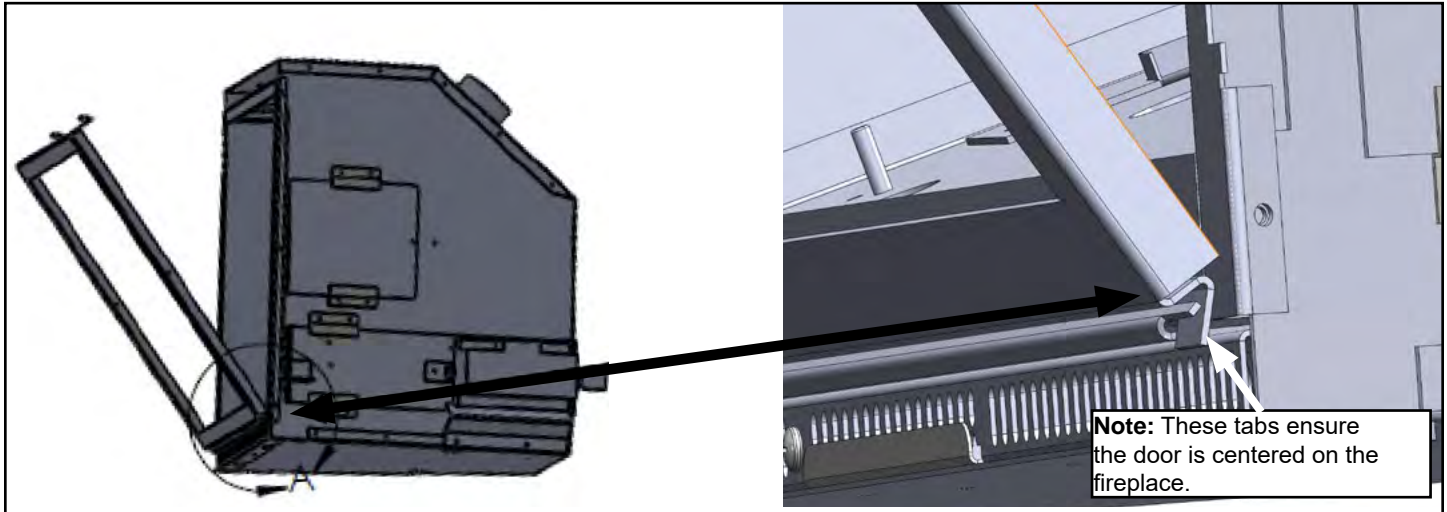

Figure 15.0.01:

Step 2: Rotate the top of the door upward.

Step 3: Rotate both door buckle release handles outward.

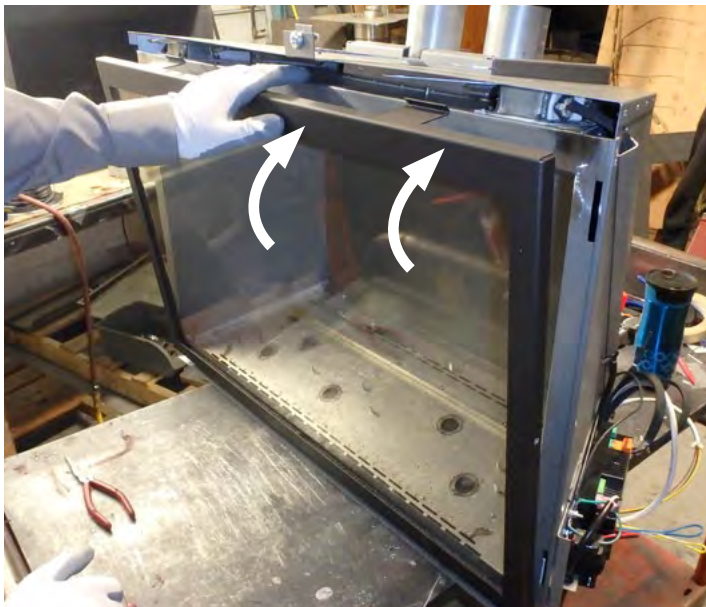

Figure 15.0.02:

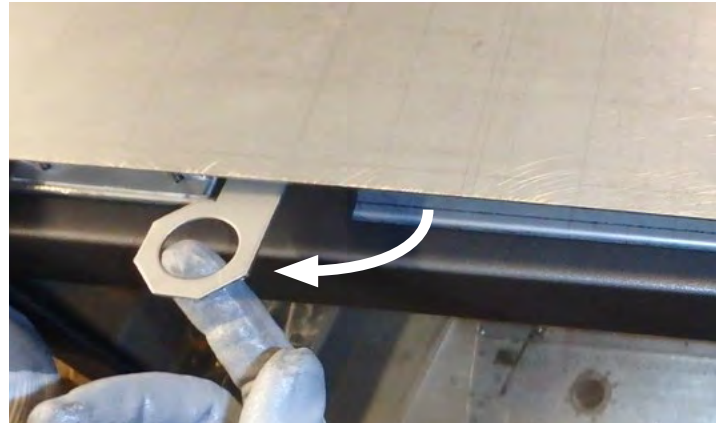

Figure 15.0.03:

Step 4: Engage the door buckles with the two hooks on the top of the door.



Figure 15.0.04:

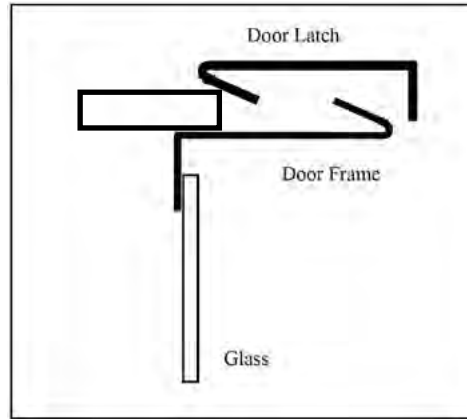

Figure 15.0.05:

*Removal is the reverse of installation.

15.1 If Your Glass Breaks

In the event your glass cracks or breaks, replace the original glass door assembly with Ambiance replacement door assembly (part number URP-891-0000).

- Remove the barrier screen (See **Section 15.0**)
- Remove the glass door according to the instructions above
- Replace with new glass door assembly and barrier screen

NOTE: the NEW door will emit some odor when the appliance is lit. The odor will dissipate after the gasket material within the door has cured. Be sure there are no fingerprints left on the glass panels as high temperatures can bake these prints on permanently.

Warning: Only doors certified with the appliance shall be used. Do not use substitute glazing materials.

16.0 Surround Installation

Before installing the surround, be sure the door is properly centered on the fireplace. Align the surround with the front of the fireplace. The surround contains four tabs (see **Figure 16.0.01**) which insert in slots in the fireplace (see **Figure 16.0.02**) to hold the surround in place. Align the tabs on both sides of the fireplace and hook the tabs in the slots to complete the install.

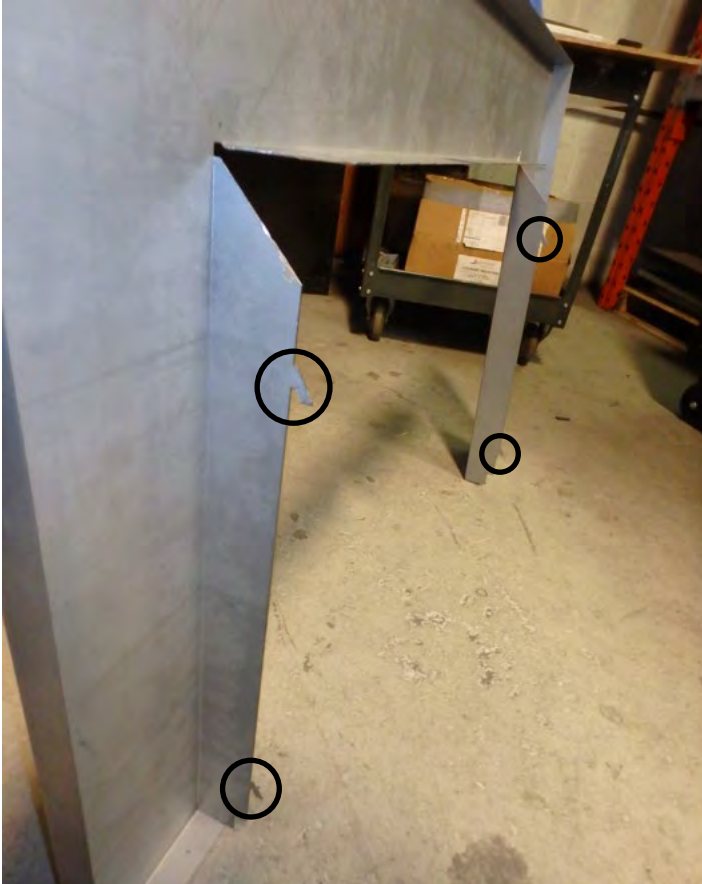

Figure 16.0.01:

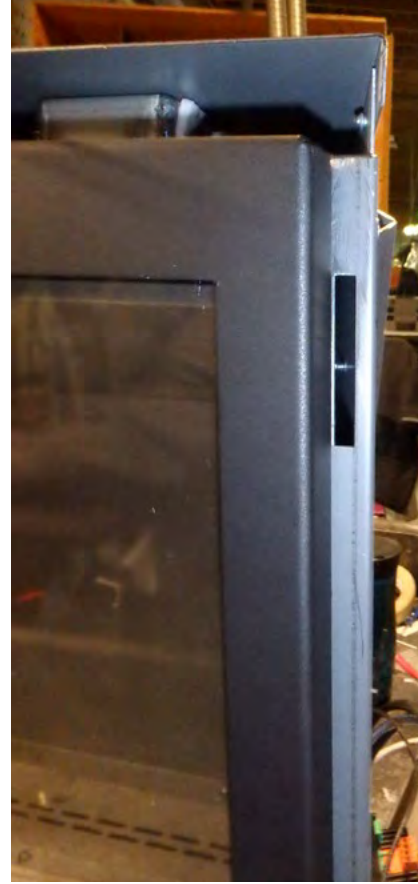

Figure 16.0.02:



Figure 16.0.03:

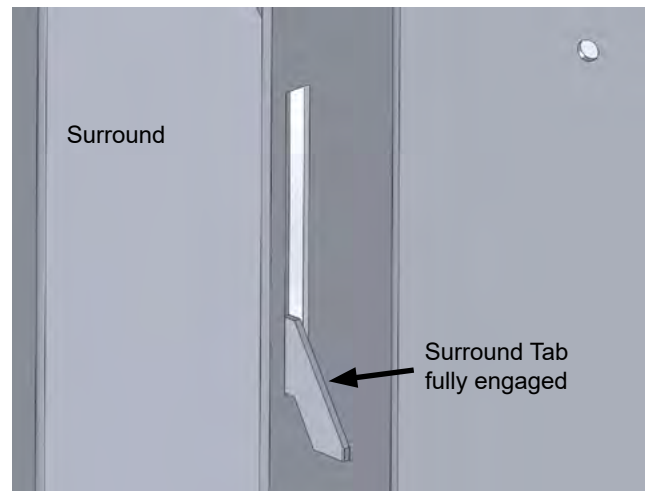

Figure 16.0.04: Surround installation drawing (view from behind the fireplace insert).

16.1 Surround Dimensions

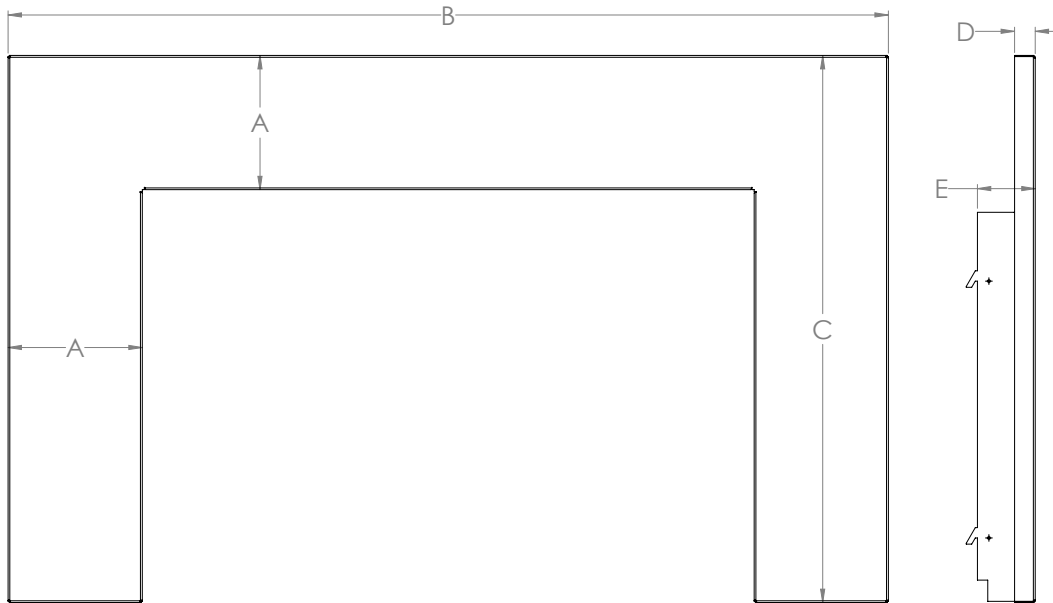

Figure 16.1.01:

	Three Sided Surrounds		
	UA6000	UA6100	UA6200
A	5" [12.7 cm]	7" [17.78 cm]	9" [22.86 cm]
B	42" [106.68 cm]	46" [116.84 cm]	50" [127 cm]
C	28.04" [71.21 cm]	30.04" [76.29 cm]	32.04" [81.37 cm]
D	1.34" [3.39 cm]		
E	2.17" [5.51 cm]		

Trimmable Surround

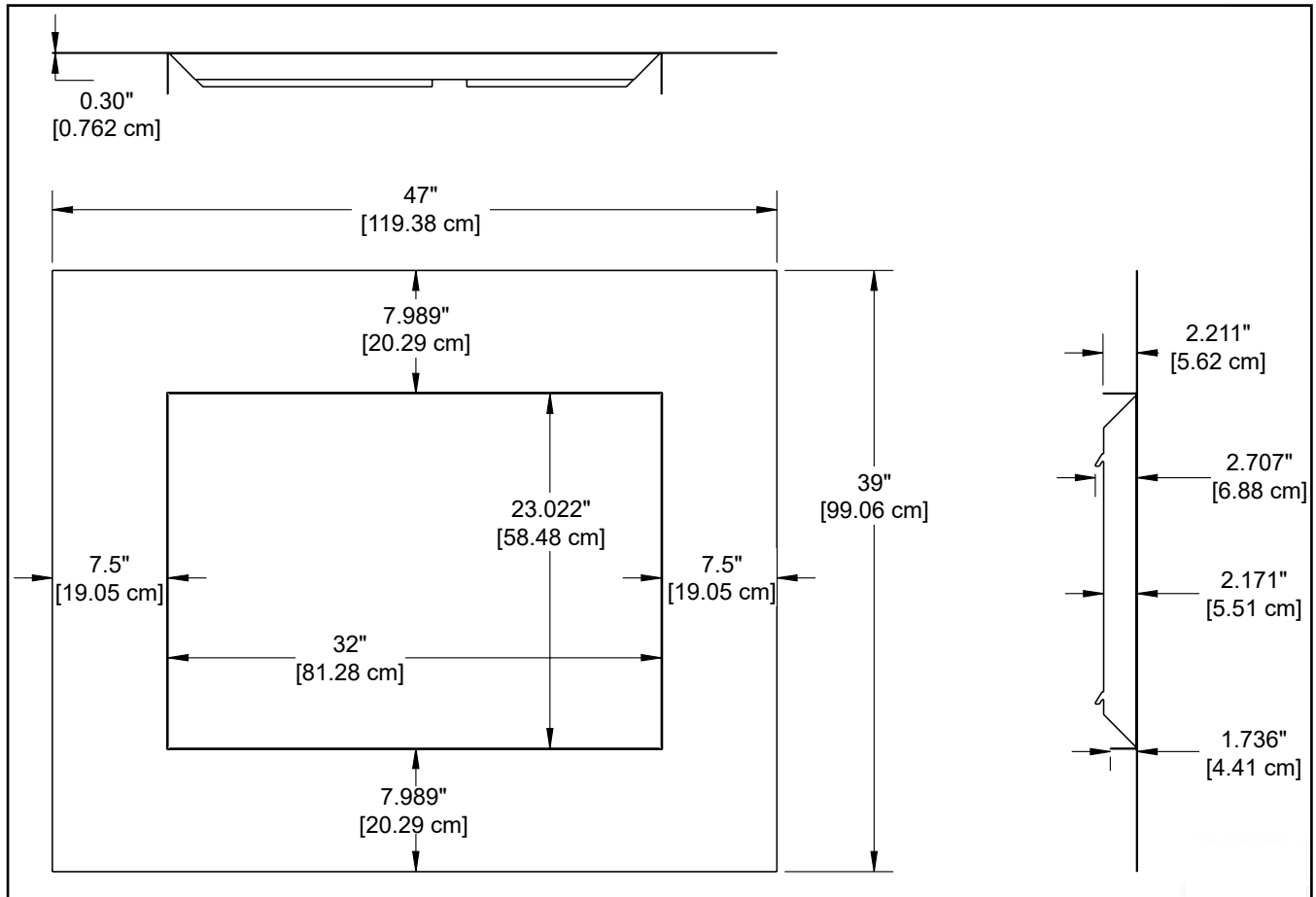

Figure 16.1.02: UA6400 Dimensions

16.2 Bottom Trim Dimensions

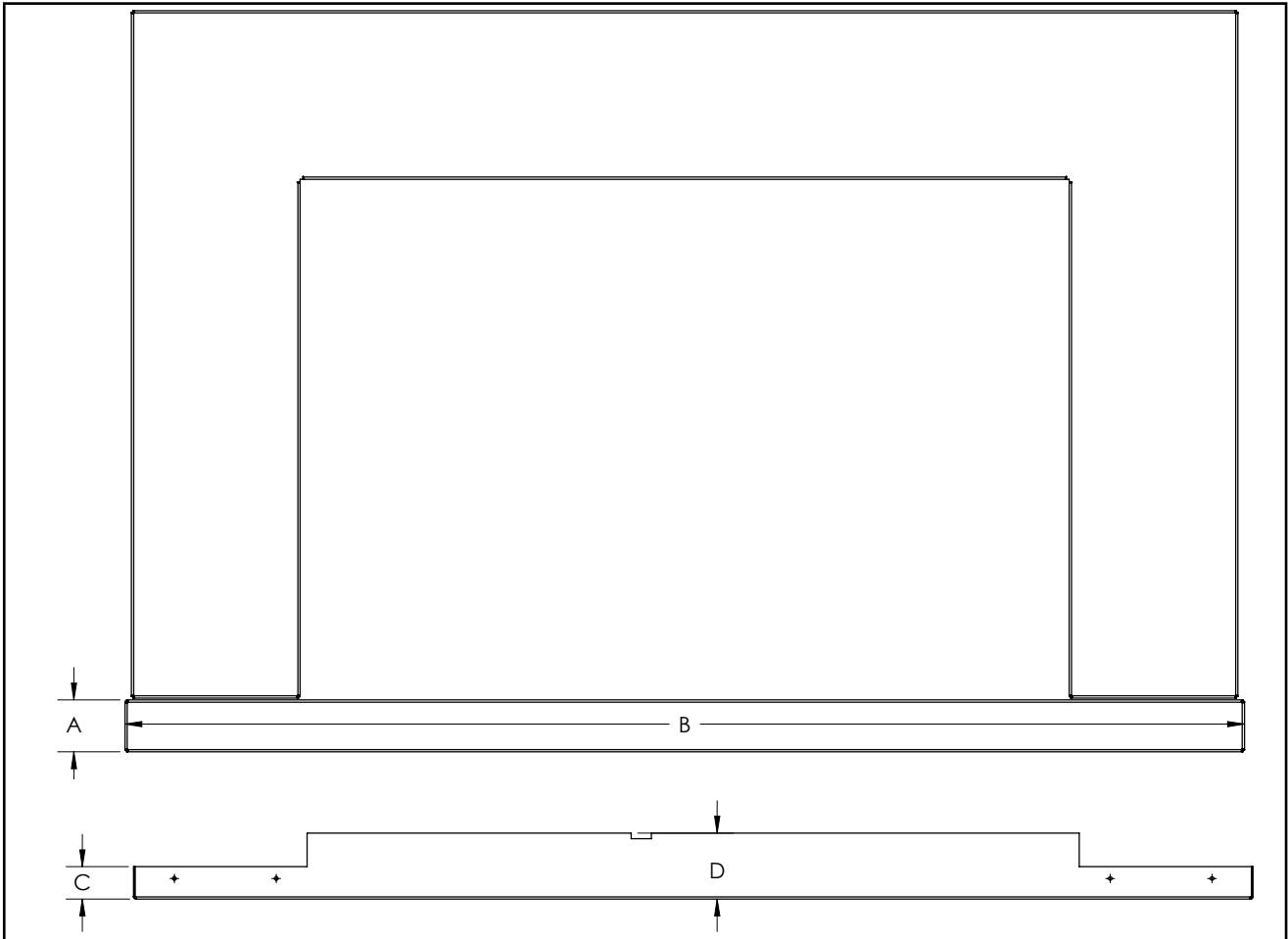

Figure 16.2.01:

	Small Trims			
	A	B	C	D
UA 6002	2" [5.08 cm]	42.5" [107.95 cm]	1.59" [4.04 cm]	1.96" [4.98 cm]
UA 6004	4" [10.16 cm]			
UA 6006	6" [15.24 cm]			

	Medium Trims			
	A	B	C	D
UA 6102	2" [5.08 cm]	46.5" [118.11 cm]	1.59" [4.04 cm]	1.96" [4.98 cm]
UA 6104	4" [10.16 cm]			
UA 6106	6" [15.24 cm]			

	Large Trims			
	A	B	C	D
UA 6202	2" [5.08 cm]	50.5" [127 cm]	1.59" [4.04 cm]	1.96" [4.98 cm]
UA 6204	4" [10.16 cm]			
UA 6206	6" [15.24 cm]			

16.3 Bottom Filler Plate

After installing the surround, align the Bottom Filler Plate included with your fireplace with the underside of the surround. Slide the plate under the lower edges on the surround as shown.

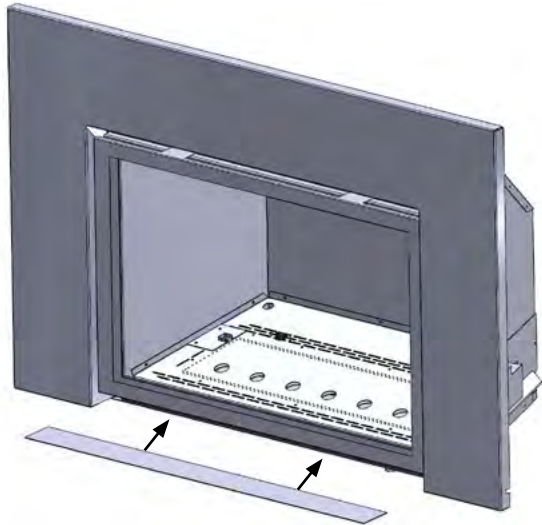

Figure 16.3.01: Align the plate.

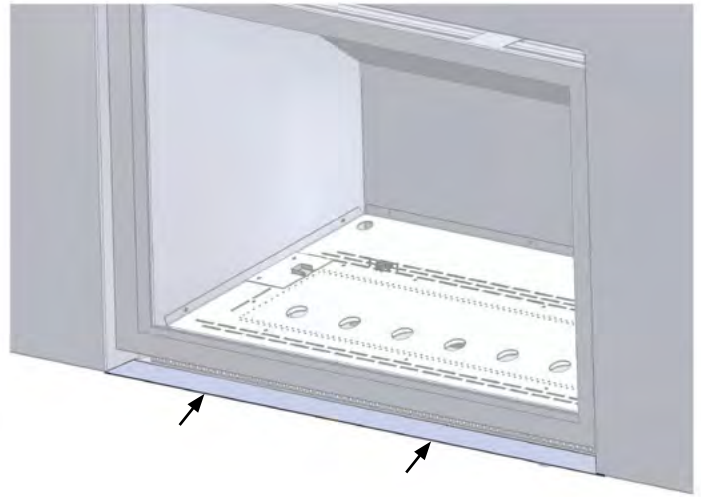

Figure 16.3.02: Slide the plate in place.

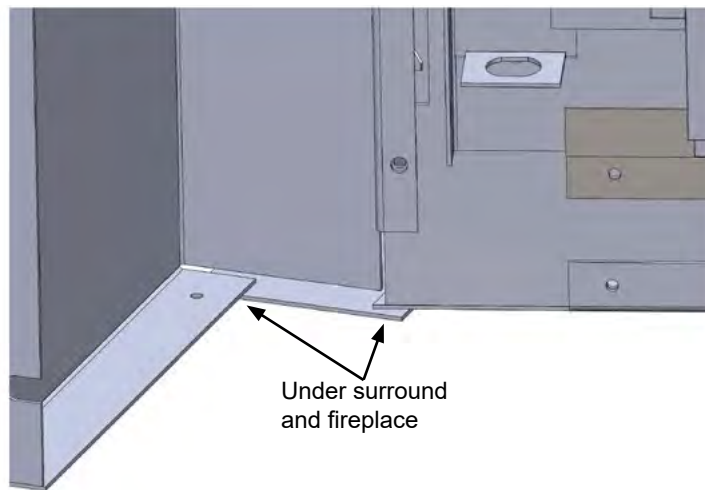

Figure 16.3.02: View from behind the surround.

17.0 Firebox Liner Installation

17.1 Brick Panel Installation

The following steps highlight the procedure for installing brick panel firebox liners. Handle the panels with care as they are delicate. Inspect the panels to ensure that no damage has occurred inside the package. Please report any damage immediately to your Authorized Ambiance Dealer.

Before you begin:

- **Ensure the gas supply is turned OFF and disconnect the power supply**
- Remove barrier screen (see **Section 14.0**)
- Remove Glass Door (see **Section 15.0**)

Step 1: Remove the Tek screws securing the upper baffle at two outside corners.



Figure 17.1.01:

Step 2: Ensure the brick retainer clips included with the fireplace are nearby.

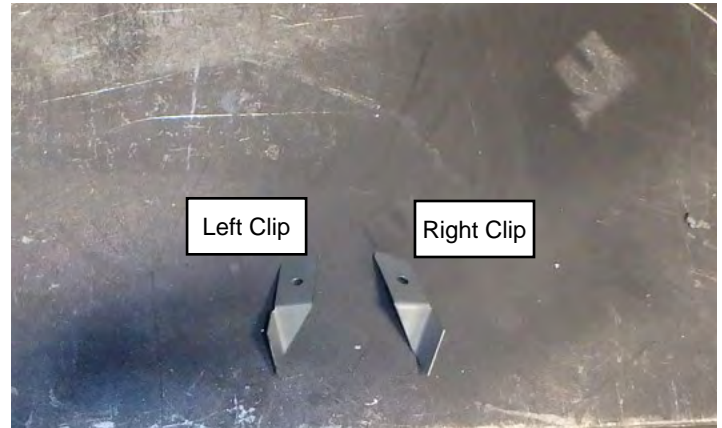

Figure 17.1.02:

Step 3: Place the rear brick panel in the back of the firebox.



Figure 17.1.03:

Step 4: Place one side in at a slight angle so that it clears the flanges on the front of the firebox.



Figure 17.1.04:

Installation

Step 5: Insert the first brick panel retainer clip using one of the screws removed in Step 1 to support the rear and the first side.



Figure 17.1.05:

Step 6: Place the top panel so that it is supported by the rear panel and the first side.



Figure 17.1.06:

Step 7: Install the remaining side at an angle.



Figure 17.1.07:

Step 8: Install the remaining brick clip using the second screw removed in Step 1.



Figure 17.1.08:



Figure 17.1.09: Completed install.

17.2 Reflective Glass Installation

The following steps highlight the procedure for installing Eternal Flame Reflective Ceramic Glass liner. Handle the panels with care. Inspect the panels to ensure that no damage has occurred inside the package. Please report any damage immediately to your Authorized Ambiance Dealer.

Before you begin:

- **Ensure the gas supply is turned OFF and disconnect the power supply**
- Remove barrier screen (see **Section 14.0**)
- Remove Glass Door (see **Section 15.0**)

Step 1: Remove the Tek screws securing the burner tray at the rear side corners.



Figure 17.2.01:

Step 2: Remove the Tek screws from the sides of the firebox adjacent to the light as shown.



Figure 17.2.02:

Step 3: Prepare the rear panel clips included with the panel set.

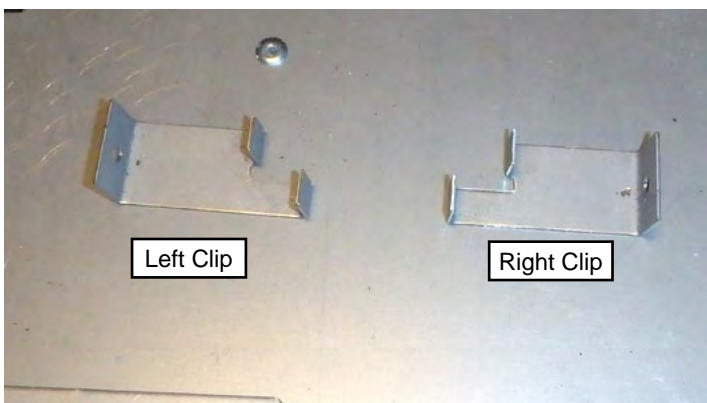

Figure 17.2.03:

Step 4: Install the left and right rear panel clips using the screws removed in Step 1.



Figure 17.2.04:

Step 5: Ensure both upper panel clips are accessible before proceeding with the next steps.

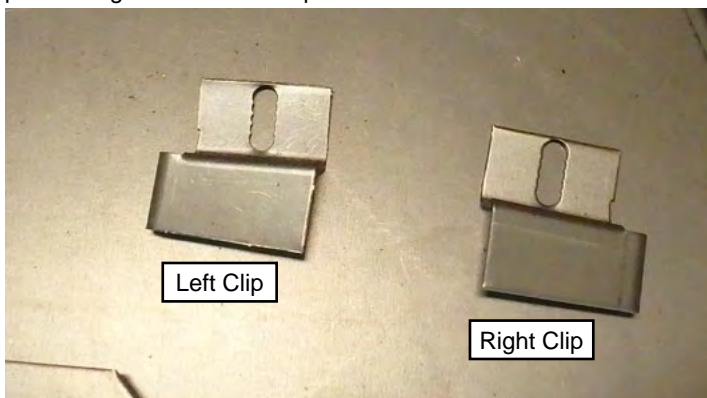

Figure 17.2.05:

Step 6: Place the rear panel in the back of the firebox.



Figure 17.2.06:

Installation

Step 7: While holding the rear panel, slide the first side panel into place. The panel fits between the two bent ends on the rear clip.

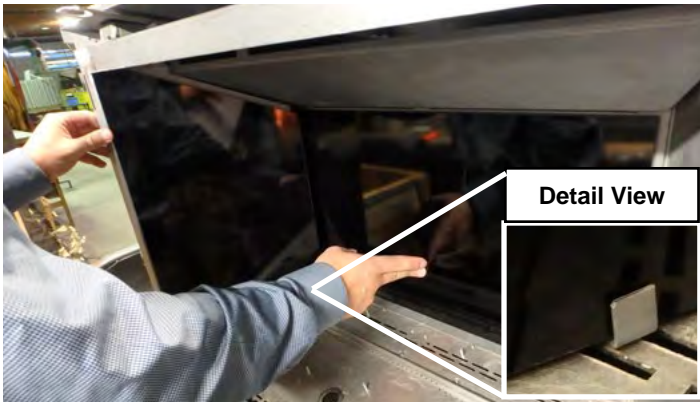

Figure 17.2.07:

Step 9: Slide the remaining side in place, ensuring proper alignment in the lower clip (see detail view in **Figure 17.2.07**).



Figure 17.2.09:

Step 11: Align the upper panel and slide backward to rest on the other three panels. The upper panel sits in front of the rear panel.



Figure 17.2.11:

Step 8: Install the first upper clip using one of the screws removed in Step 2.



Figure 17.2.08:

Step 10: Install the remaining upper panel clip using the second screw removed in Step 2.



Figure 17.2.10:



Figure 17.2.12: Completed Install

18.0 Media Installation

WARNING

Failure to position the parts in accordance with these diagrams or failure to use only parts specifically approved with this appliance may result in property damage or personal injury.

18.1 Log Set (UF0600)

The Ambiance pan burner bed and fiber logs are designed to give a realistic fire package, and created to look the same as the day they were originally installed. Care must be given when first installing the logs, and if removed for servicing, as they can be damaged or broken if not handled properly.

After opening the log set package, inspect the logs to ensure that no damage has occurred inside the package. Please report any damage immediately to your Authorized Ambiance Dealer.

Gas and vent connection must be made before installing the embers and logs on the pan burner.

CAUTION: DO NOT block pilot opening with embers or glass media material.

NOTE: Improper placement of logs and embers may cause soot accumulation on the internal parts and glass. This is not covered under warranty. Do not use broken or damaged logs.

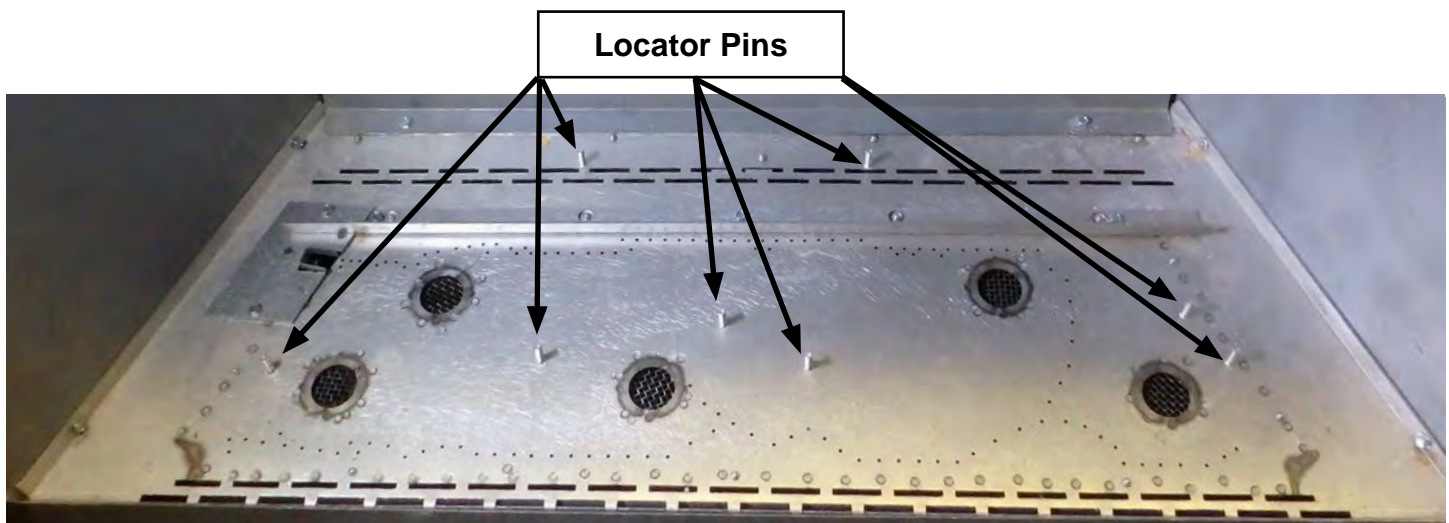

Figure 18.1.01:

Log 1: Align the holes of log 1 with the two locator pins at the back of the burner. Set the log onto the pins with gentle force. The right side of log 1 will wrap over the edge of the burner baffle.

Log 2: Place log 2 on the lower left front of the burner. Align the hole in the bottom of the log with the pin and set the log into place.

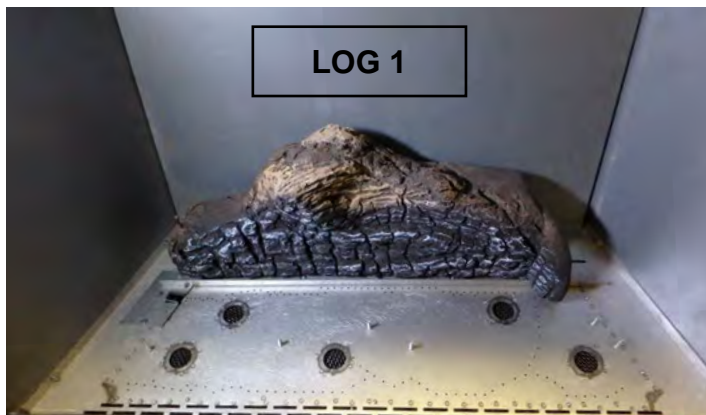

Figure 18.1.02:

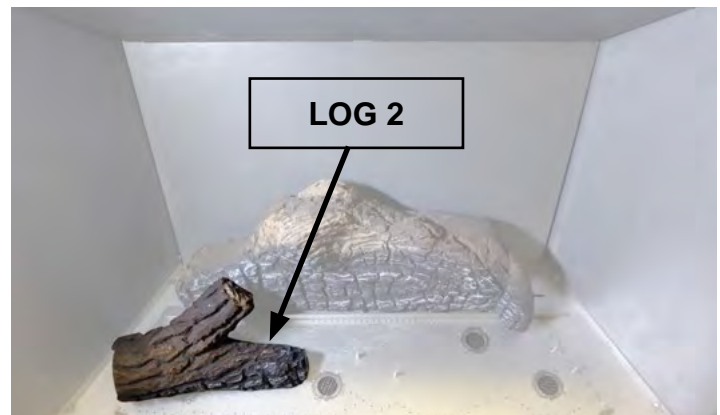

Figure 18.1.03:

Installation

Log 3: Place log 3 on the right front side of the burner. Gently push onto the two locator pins.

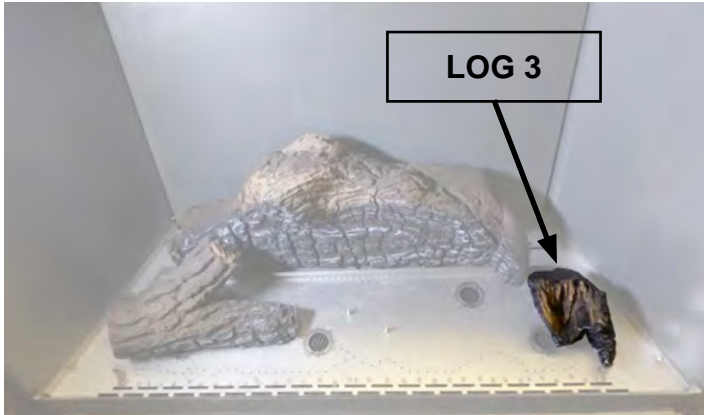

Figure 18.1.04:

Log 4: Rest the back of log 4 on the locator pin on the back edge of log 3. Place the front of log 4 onto the burner locator pin.

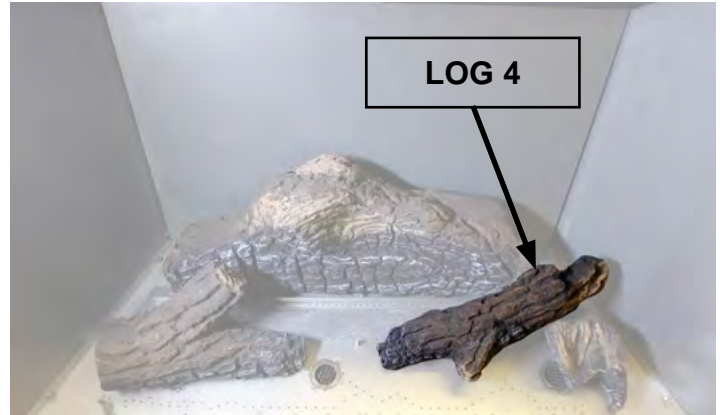

Figure 18.1.05:

Log 5: Rest log 5 on top of log 1 along the rear right hand side. The right side of log 5 rests in the notch in log 4.

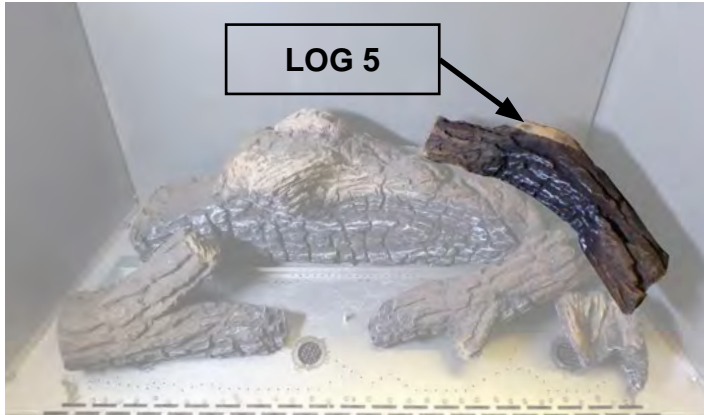

Figure 18.1.06:

Log 6: Rest log 6 on top of log 1 along the rear left hand side. The left side of log 6 rests on the left side of log 2.

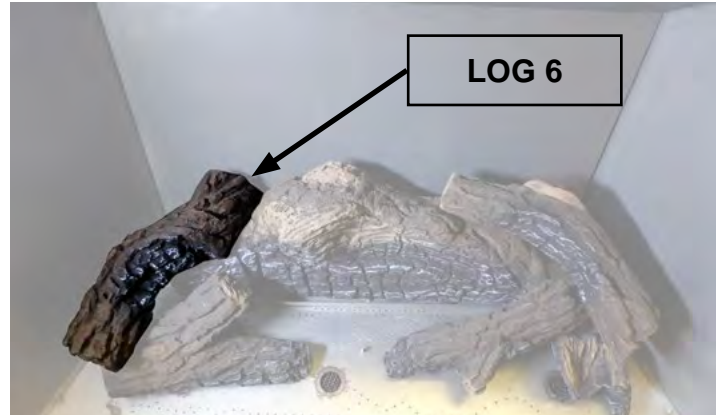

Figure 18.1.07:

Log 7: Rest the sculpted hollow end of log 7 on top of log 4 and angle the log back and to the left as shown. Place log 7 so that it cannot fall backward.

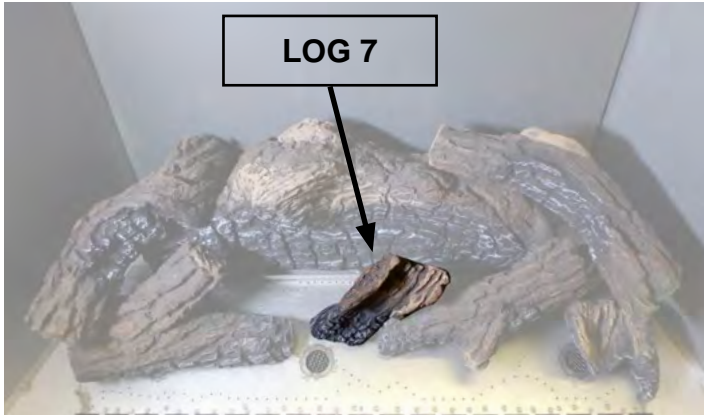

Figure 18.1.08:



Figure 18.1.09:

WARNING

Failure to position the logs in accordance with the preceding diagrams or failure to use only parts specifically approved with this appliance may result in property damage or personal injury.

Ember Placement

IMPORTANT

Embers should be placed so they do not completely block burner ports. DO NOT block pilot opening.

One bag of embers is packaged with the log set. A second bag is included with the UF0600 packaging. Place embers in a single even layer. Do not pile or stack the embers. Be sure to include the areas between the logs. Leave a little space in front of log 1 to allow for secondary air. Do not block the pilot opening located on the left side of the burner.



Figure 18.1.10:



Figure 18.1.11:



Figure 18.1.12:

Finally, install the platinum embers by pulling them apart and distributing them across the burner ports. The wool will help flame carry over and burn bright and beautiful.



Figure 18.1.13:



Figure 18.1.14: final install

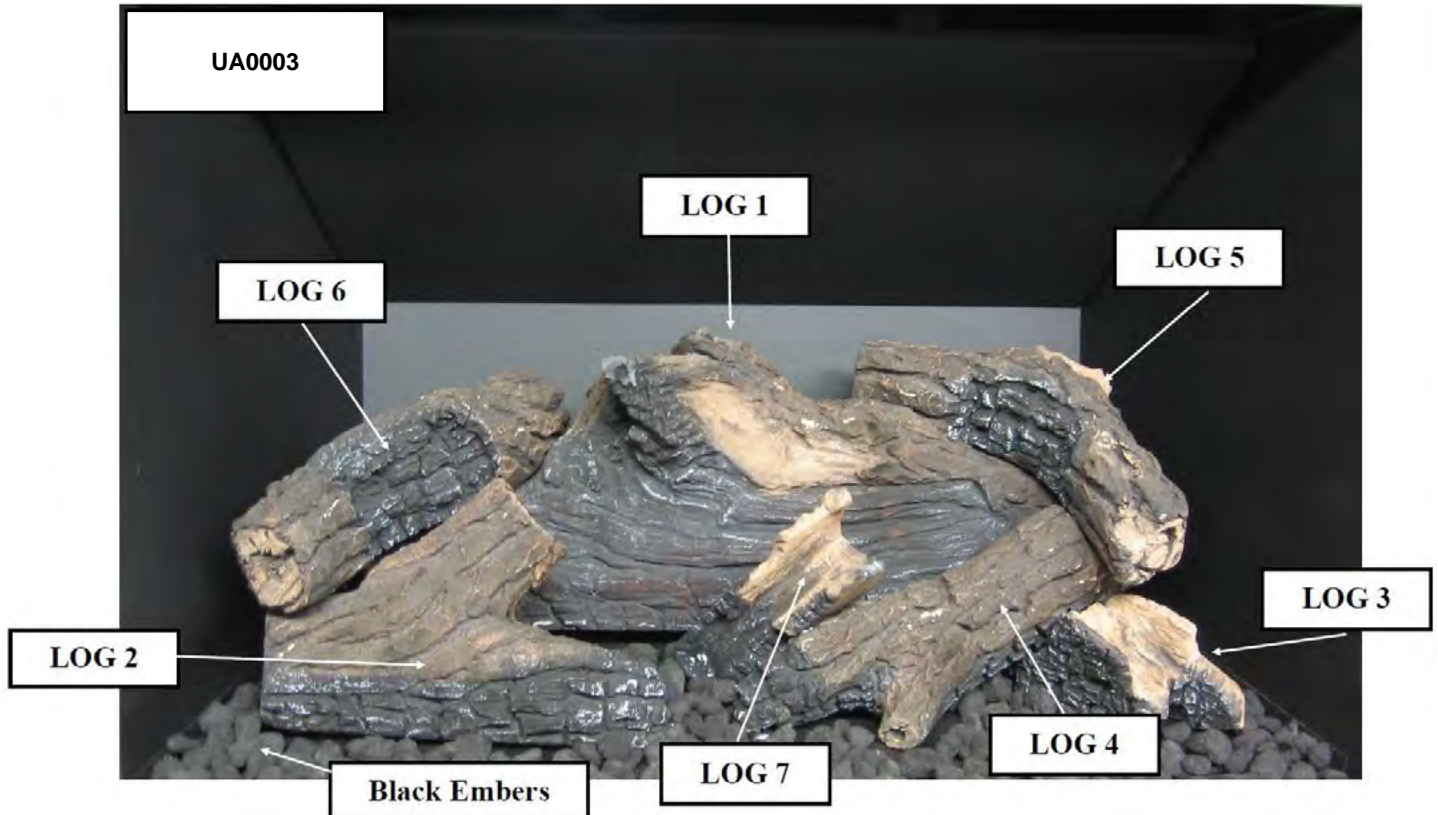

Figure 18.1.15:

Part #	Item Description	Qty	Part #	Item Description	Qty
UA0003	UF0600 Log Set	1 Set	UA0003-5	Log 5 (Upper Right)	1
UA0003-1	Log 1 (Middle Rear)	1	UA0003-6	Log 6 (Upper Left)	1
UA0003-2	Log 2 (Front Left)	1	UA0003-7	Log 7 (Middle Twig)	1
UA0003-3	Log 3 (Front Right)	1	310-0020	Black Embers (2 cup bag)	1
UA0003-4	Log 4 (Middle Right)	1	310-0019	Platinum Embers (1 bag)	1

WARNING	Never use unapproved burner media such as rock wool or similar material. The use of unapproved burner media may cause damage or injury and will void product warranty.
----------------	--

WARNING	The log set is only for use with the UF0600 burner. DO NOT place logs or embers on the UF0610 contemporary burner.
----------------	--

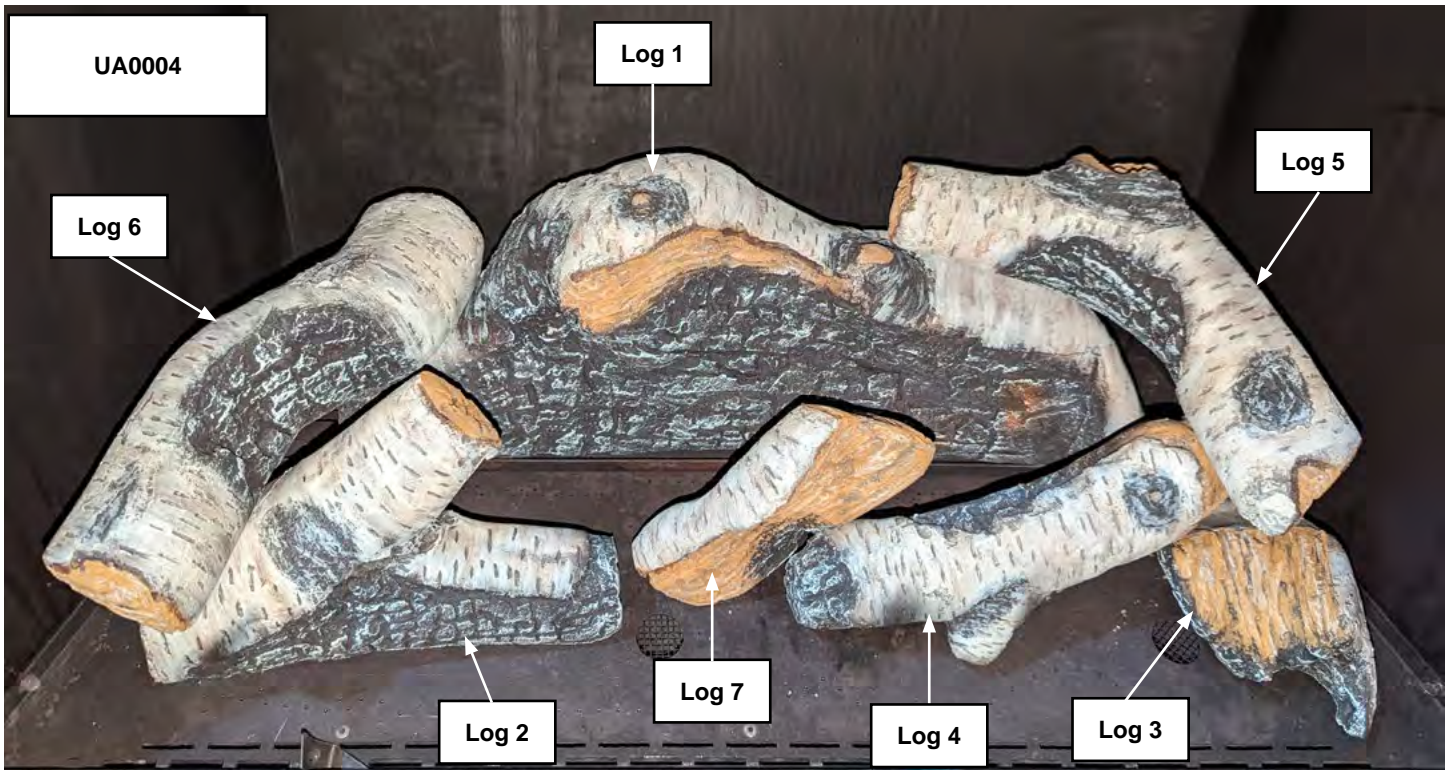

Figure 18.1.16:

Part #	Item Description	Qty	Part #	Item Description	Qty
UA0004	UF0600 Log Set	1 Set	UA0004-5	Log 5 (Upper Right)	1
UA0004-1	Log 1 (Middle Rear)	1	UA0004-6	Log 6 (Upper Left)	1
UA0004-2	Log 2 (Front Left)	1	UA0004-7	Log 7 (Middle Twig)	1
UA0004-3	Log 3 (Front Right)	1	310-0020	Black Embers (2 cup bag)	1
UA0004-4	Log 4 (Middle Right)	1	310-0019	Platinum Embers (1 bag)	1

WARNING	Never use unapproved burner media such as rock wool or similar material. The use of unapproved burner media may cause damage or injury and will void product warranty.
----------------	--

WARNING	The log set is only for use with the UF0600 burner. DO NOT place logs or embers on the UF0610 contemporary burner.
----------------	--

18.2 Fire Beads (UF0610)

The UF0610 comes from the factory with the contemporary burner installed. This unit is furnished with colored glass beads or ceramic rocks instead of the traditional log set to give your fireplace a sleek cosmopolitan look.

Installation of fire beads is as simple as spreading the beads you have chosen evenly over the burner so that it is completely covered.

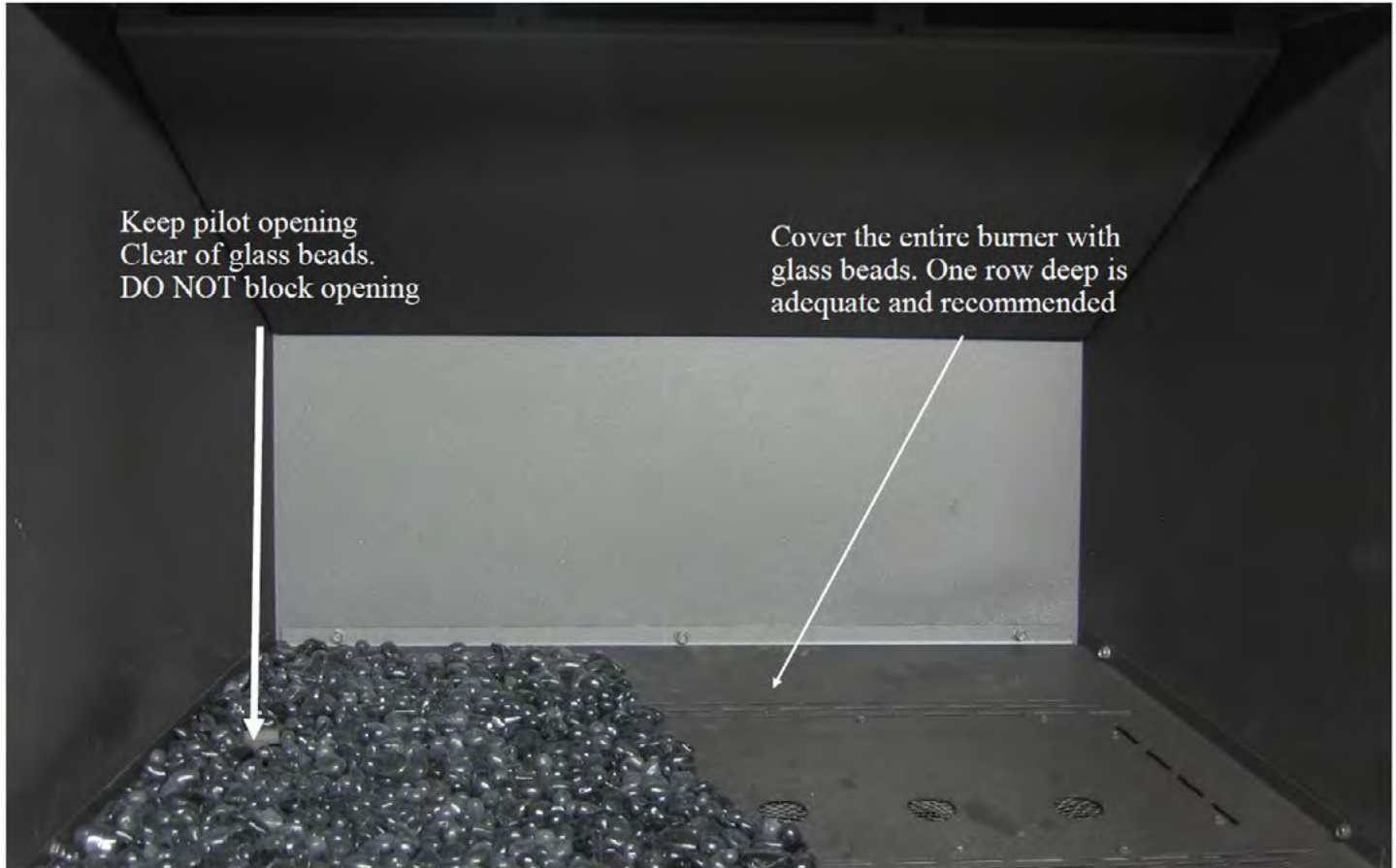

Figure 18.2.01:

WARNING	Glass media is only for use with the UF0610 burner. DO NOT place glass media on the UF0600 log burner.
ATTENTION	When placing fire beads around the pilot shield take care to not block the pilot opening. Failure to keep the opening clear of burner media will cause a delayed ignition.
ATTENTION	The UF0610 is designed for use with fire beads and it is not recommended to use broken glass or other sharp edged glass pieces. Nonconforming glass may result in a less than optimal burn presentation.

18.3 River Rocks (UF0610)

The Mississippi River Rocks should be installed in three steps.

Step 1: randomly place the larger size rocks so they do not completely block the burner ports or the round secondary air ports.



Figure 18.3.01:

Step 2: Randomly fill the gaps with the medium size rock so they do not directly block off the air or burner ports. They can be placed over the ports as long as they do not completely block them.



Figure 18.3.02:

Step 3: Fill the gaps with the remaining small stones. It is important not to double stack the stones particularly over the burner ports. This will cause an excessive amount of blue flame.



Figure 18.3.03:

19.0 Operation

WARNING

NEVER OPERATE THIS APPLIANCE WITHOUT THE BARRIER SCREEN INSTALLED.

19.1 Before Lighting

WARNING: If you do not follow these instructions exactly, a fire or explosion may result causing property damage, personal injury or loss of life. Do not operate the appliance with the glass front removed, cracked or broken. Replacement of broken glass should be done by a licensed or qualified service person.

Each Ambiance Gas Fireplace is checked and tested at the factory prior to being packaged and shipped to our dealers and finally installed in your home. Before leaving this unit with the customer, the installer must ensure that the appliance is firing correctly and that the electrical system is in working order. This will include:

1. Performing leak tests of supply line, gas control valve, supply line from gas control valve and pilot assembly.
2. Clocking the appliance to ensure the correct firing rate (see page 6 of this manual).
3. If required, adjusting the primary air to burner to ensure that the flame does not carbon or soot.
4. Checking for proper operation including correct drafting.
5. Turning the fireplace ON to ensure that the fan is working correctly. After the system has been checked and confirmed that the fan is in working order, refer to the instructions for FIRST FIRE located in this manual.

Use the installation checklist in **Section 5.0** to ensure all installation steps have been completed.

Note: Any alteration to this product that causes carbon or soot deposits that results in any damage or requires cleaning is not the responsibility of the manufacturer.

Do not store or use gasoline or other flammable vapors and liquids in the vicinity of this or any other appliance.

WHAT TO DO IF YOU SMELL GAS:

- Do not try to light any appliance.
- Do not touch any electrical switch; do not use any phone in your building.
- Immediately call your gas supplier from a neighbor's phone. Follow the gas supplier's instructions.
- If you cannot reach your gas supplier, call the fire department.

Installation and service must be performed by a qualified installer, service agency or the gas supplier.

1. **BEFORE LIGHTING**, smell all around the appliance area for gas. Be sure to smell next to the floor, because some gasses are heavier than air and will settle on the floor.
2. **IF YOU SMELL GAS**, follow the instructions as listed directly above or as shown on the front cover of this manual.
3. Do not use this appliance if any part has been under water. Immediately call a qualified service technician to inspect the appliance and to replace any part of the control system and any gas control which has been under water.
4. This appliance is equipped with an ignition device which automatically lights the pilot and main burner when operating the remote control.

19.2 First Fire

When operated for the first few times, the appliance will emit some odor and fumes. This is due to the heat from the appliance evaporating the oils and solvents used in fabricating the appliance. Close off the room to the rest of the house and open all windows. Keep the room well ventilated, as smoke alarm may sound. Run the appliance for at least 6 hours at maximum setting with blower set to "OFF" to allow paint to cure (after the installer has checked to ensure the fan is operational). Smoke and fumes caused by the curing process may cause discomfort to some individuals. Clean the glass door after this curing process has completed (see **Section 20.1**). Be sure there are no fingerprints left on the glass panels as high temperatures can bake these prints on permanently.

19.3 Lighting Instructions

The following information may be found on the fireplace rating plate. See **Section 6.1** for the rating plate location.

FOR YOUR SAFETY READ BEFORE LIGHTING
POUR VOTRE SÉCURITÉ VEUILLEZ LIRE AVANT L'ALLUMAGE

WARNING: If you do not follow these instructions exactly, a fire or explosion may result causing property damage, personal injury or loss of life.

AVERTISSEMENT: Quiconque ne respecte pas à la lettre les instructions dans la présente notice risque de déclencher un incendie ou une explosion entraînant des dommages, des blessures ou la mort.

A. This appliance is equipped with an ignition device which automatically lights the pilot. Do not try to light the pilot by hand. When lighting the pilot follow these instructions exactly.

B. BEFORE OPERATING smell all around the appliance area for gas. Be sure to smell next to the floor because some gas is heavier than air and will settle on the floor.

WHAT TO DO IF YOU SMELL GAS

- Do not try to light any appliance.
- Do not touch any electrical switch; do not use any phone in your building.
- Immediately call your gas supplier from a neighbor's phone. Follow the gas supplier's instructions
- If you cannot reach your gas supplier, call the fire department.

C. Do not use this appliance if any part has been under water. Immediately call a qualified service technician to inspect the appliance and to replace any part of the control system and any gas control which has been under water.

A. Cet appareil est équipé d'un dispositif d'allumage qui allume automatiquement la veilleuse. N'essayez pas d'allumer la veilleuse à la main.. Respectez les instructions ci-dessous à la lettre.

B. AVANT D'ALLUMER la veilleuse, reniflez tout autour de l'appareil pour détecter une odeur de gaz. Reniflez près du plancher, car certains gaz sont plus lourds que l'air et peuvent s'accumuler au niveau du sol.

QUE FAIRE SI VOUS SENTEZ UNE ODEUR DE GAZ:

- Ne pas tenter d'allumer d'appareil
- Ne touchez à aucun interrupteur; ne pas vous servir des téléphones se trouvant dans le bâtiment
- Appelez immédiatement votre fournisseur de gaz depuis un voisin. Suivez les instructions du fournisseur.
- Si vous ne pouvez rejoindre le fournisseur, appelez le service des incendies.

C. N'utilisez pas cet appareil s'il a été plongé dans l'eau, même partiellement. Faites inspecter l'appareil par un technicien qualifié et remplacez toute partie du système de contrôle et toute commande qui ont été longés dans l'eau.

LIGHTING INSTRUCTIONS
INSTRUCTION D'ALLUMAGE

1. STOP! Read the safety information above on this label. This appliance is equipped with an ignition device which automatically lights the pilot. Do not try to light the pilot by hand.
2. Set the remote control switch to "OFF".
3. Open the lower louvers, or remove trim and barrier screen.
4. Turn off all electric power to the appliance.
5. Open the gas isolation valve.
6. Wait 5 minutes to clear out any gas. Then smell for gas, including near the floor. If you smell gas, STOP! and follow "B" in the safety information above (and to the left) on this label. If you do not smell gas, go to the next step.
7. Turn on all electric power to the appliance.
8. Set the remote control switch to "ON".
9. If the fireplace does not light, the system will cycle through two trials (one minute of audible clicking, thirty seconds of silence, and then another one minute of audible clicking). If the system locks out due to inadequate gas flow, refer to troubleshooting in instruction manual.
10. If the system will not function correctly, follow the instructions "To turn Off Gas To Appliance" below and call your service technician or gas supplier.
11. Replace louver or trim.

1. ARRÊTEZ! Lisez les instructions de sécurité sur la portion supérieure (à droite) de cette étiquette. Cet appareil est équipé d'un dispositif d'allumage qui allume automatiquement la veilleuse. N'essayez pas d'allumer la veilleuse à la main.
2. Réglez le commutateur à distance sur "OFF".
3. Ouvrez persiennes inférieurs ou garnir.
4. Coupez l'alimentation électrique de l'appareil.
5. Vanne d'isolement de gaz ouverte.
6. Attendez cinq (5) minutes pour laisser échapper tout le gaz. Reniflez tout autour de l'appareil, y compris près du plancher, pour détecter un odeur de gaz. Si vous sentez une odeur de gaz, ARRÊTEZ! Passez à l'étape B des instructions de sécurité sur la portion supérieure (à gauche) de cette étiquette. S'il n'y a pas d'odeur de gaz, passez à l'étape suivante.
7. Réglez le commutateur à distance sur "ON".
8. Allumez l'alimentation électrique de l'appareil.
9. Si le foyer ne se allume pas, le cycle de la volonté du système grâce à deux essais (une minute de clic audible, trente secondes de silence, et puis un autre une minute de clic audible). Si le système se bloque en raison de l'écoulement de gaz insuffisante, voir le dépannage dans le manuel d'instruction.
10. Si le système ne fonctionne pas correctement, suivez les instructions «Pour couper le gaz de l'appareil» ci-dessous et appelez votre technicien d'entretien ou fournisseur de gaz.
11. Persienne fermée ou garnir.

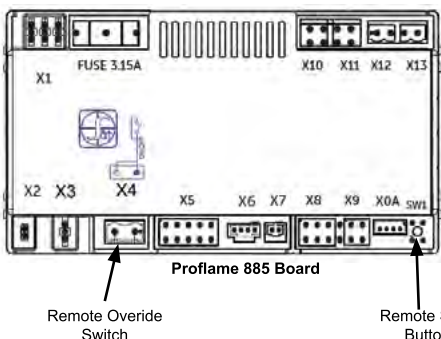

Proflame 885 Board

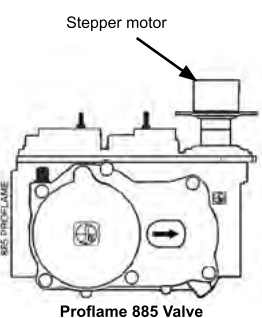

Proflame 885 Valve

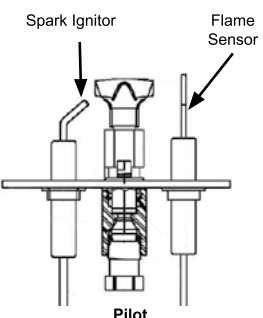

Pilot

TO TURN OFF GAS TO APPLIANCE
POUR COUPER LE GAZ À L'APPAREIL

1. Set the remote control switch to "OFF".
2. Turn off all electric power to the appliance if service is to be performed.
3. Open louver or access panel.
4. Turn incoming gas isolation valve to "OFF" position.
5. Close louver or trim.

1. Réglez le commutateur à distance sur "OFF".
2. Coupez l'alimentation électrique de l'appareil s'il faut procéder à l'entretien.
3. Ouvrez persiennes inférieurs ou porte d'accès.
4. vanne d'isolement de gaz à proximité
5. Persienne fermée ou garnir.

Figure 19.3.1:

19.4 Dynamic Start Advantage

This fireplace comes standard with the Dynamic Start Advantage. This new electronic ignition system is the latest in fireplace technology. It helps to create a better draft, better flame appearance, less condensation on the glass, and years of carefree operation.

How the system works:

When starting a solid fuel wood burning fireplace you build a fire. You start with a little bit of tinder and kindling to create small fire, and then work your way up to larger logs once a draft has been established. Dynamic Start uses the same principle. When you press the "ON" button on the remote control the main burner will light and remain with a low flame for two minutes. This will first establish a draft in the vent and slowly warm up the fireplace. When two minutes have passed, the main burner will automatically ramp up to the high flame (or whichever setting you have established on the remote control).

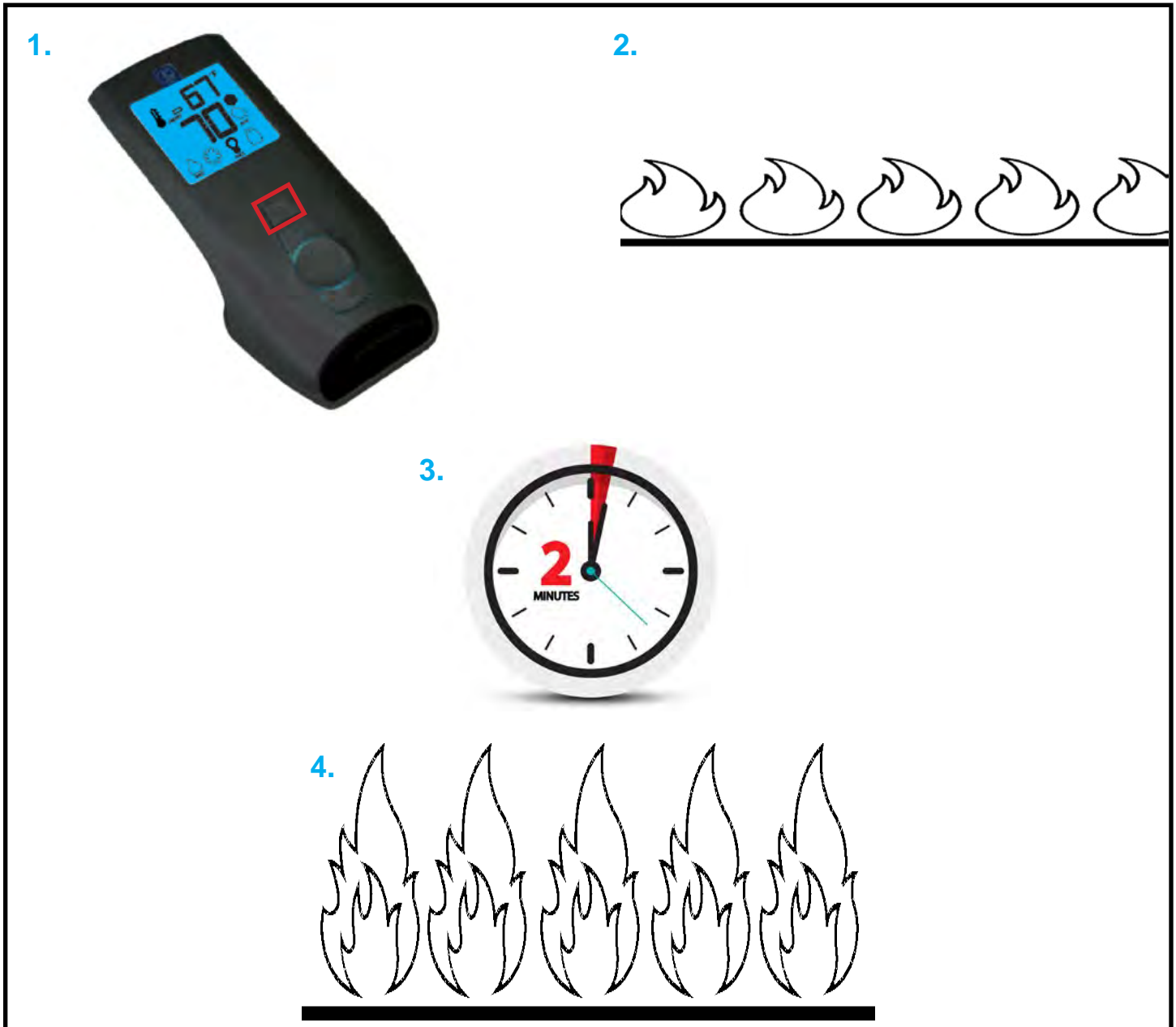

Figure 19.4.01

19.5 Remote Control Operation

IMPORTANT

The Proflame II Remote is an integrated part of the Proflame II System, which consists of a Proflame II Remote, to be used in conjunction with Integrated Fireplace Control (Proflame II Control Module).



Figure 19.5.01

The Proflame II Remote provides for controlling the following hearth appliance functions:

1. Main Burner ON/OFF
2. Main Burner flame modulation (6 levels)
3. Choice of Continuous Pilot on Demand or intermittent pilot (CPI/IPI)
4. Thermostat and SMART thermostat function
5. Comfort fan speed modulation (6 levels)
6. Variable lights (6 levels)

The Proflame Remote uses a streamline design with a simple button layout and informative LCD display. A Mode Key is provided to index between the features and a Thermostat Key is used for on/off or to index through the thermostat function. Additionally a Key Lock function is provided.

ATTENTION

- TURN OFF THE MAIN GAS SUPPLY DURING INSTALLATION OR MAINTENANCE OF THE RECEIVER DEVICE
- TURN OFF MAIN GAS SUPPLY TO THE APPLIANCE PRIOR TO REMOVING OR REINSERTING THE BATTERIES
- IN CASE OF REMOTE CONTROL MALFUNCTION TURN OFF THE FIREPLACE BY REMOVING POWER SUPPLY (INCLUDING BACKUP BATTERIES)
- FOR INSTALLATION/MAINTENANCE SWITCH OFF THE FIREPLACE BY REMOVING POWER SUPPLY (INCLUDING BACKUP BATTERIES)

Technical Data - Remote Control

Supply Voltage	4.5 V (three (3) 1.5V AAA batteries)
Ambient temperature ratings	0 - 50°C (32 - 122°F)
Radio Frequency	315 MHz

Handheld Remote Display

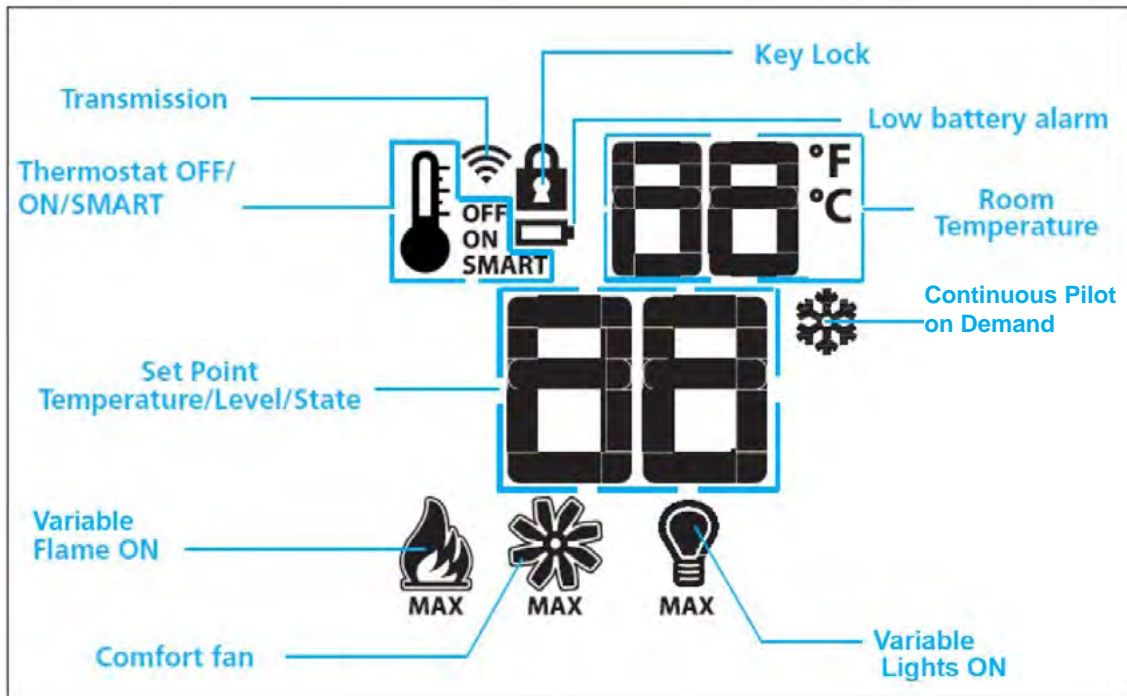

Figure 19.5.02

WARNING

THE REMOTE AND RECEIVER ARE RADIO FREQUENCY DEVICES. PLACING THE REMOTE IN OR NEAR METAL ENCLOSURES MAY REDUCE THE SIGNAL RANGE.

Wall Mountable Remote (optional)



Figure 19.5.03

Initializing the System for Wall Mount / Handheld Remote Operation

1. Connect IFC Control Module to AC power supply. A single “beep” will indicate the presence of power. **NOTE: This will initiate Pilot Start-up in Manual Mode. The pilot will spark repeatedly and ignite if gas has been supplied to the unit. Sync the control board to the remote to turn main burner and pilot off using the steps below.**
2. The ON/OFF Override Jumper on the control board must be connected.
3. Press and hold the red SW1 button until the IFC module beeps three (3) times and/or the amber LED illuminates indicating the module is ready to synchronize with the remote.
4. Within ten (10) seconds push the ON/OFF key on the remote. The IFC module will “beep” four (4) times to indicate that it has successfully synced with the remote. Turn the fireplace OFF using the ON/OFF button on the remote to complete initialization. The remote will now control the fireplace.
5. Install the provided four (4) AA batteries into battery back up holder.

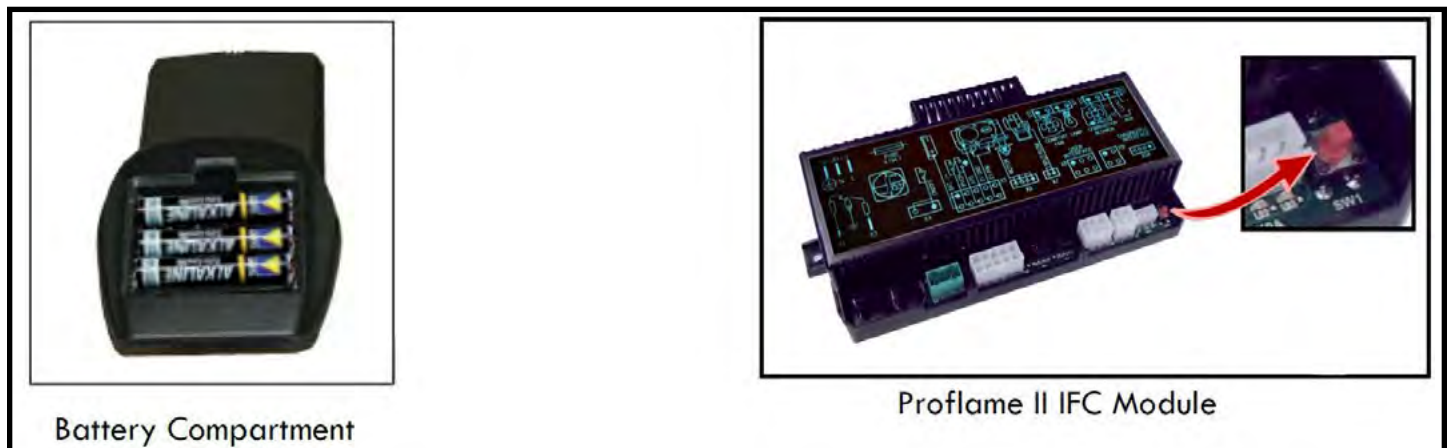

Figure 19.5.04:



Figure 19.5.05:

Temperature Indication Display

With the system in the “OFF” position, press the Thermostat Key and the Mode Key at the same time to switch between Fahrenheit (F) or Celsius (C). Verify on the LCD screen the correct designation is visible.

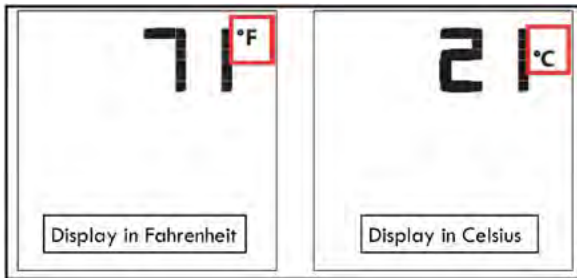

Figure 19.5.06:

Variable Flame Control This function is disabled when in SMART Thermostat Mode and does not operate in the first two minutes of operation during the Dynamic Start Advantage.

The Proflame IFC has six (6) flame levels. With the system “ON” and the flame at maximum in the appliance, pressing the Down Arrow Key once will reduce the flame height by one step. Repeat to lower the flame till “OFF”. With flame OFF in this configuration, fan and lights will still be operational.

The UP Arrow Key will increase the flame height each time it is pressed.

If the UP Arrow Key is pressed while the system is on but the flame is off, the flame will activate in the high setting.

A single “beep” will confirm reception of the command.

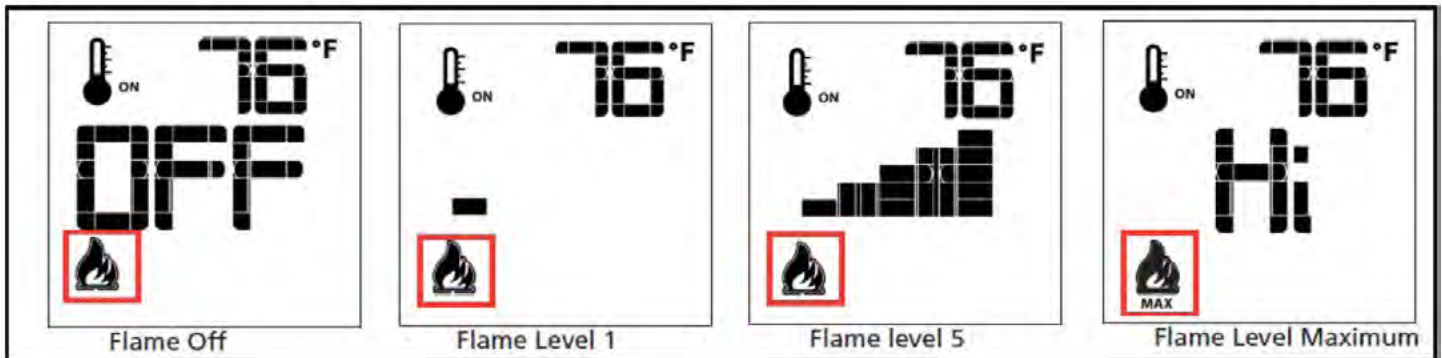

Figure 19.5.07:

Fan Speed Control

If the appliance is equipped with a hot air circulating fan, the speed of the fan can be controlled by the Proflame system. The fan speed can be adjusted through six (6) speeds. To activate this function use the Mode Key to index to the fan control icon. Use the Up/Down Arrow Keys to turn on, off or adjust the fan speed. A single “beep” will confirm reception of the command.

In manual mode the fan will activate immediately upon burner ignition. Adjust the fan speed to personal preference. Blower will shut off when the burner is extinguished.

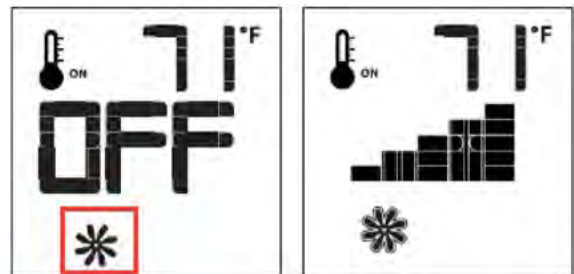

Figure 19.5.08:

Dimmer Control (Light)

This function is used to control the variable lights. To activate this function use the Mode Key to index to the variable light icon.

The intensity of the output can be adjusted through six (6) levels. Use the Up/Down Arrow Keys to adjust the output level. A single "beep" will confirm reception of the command.

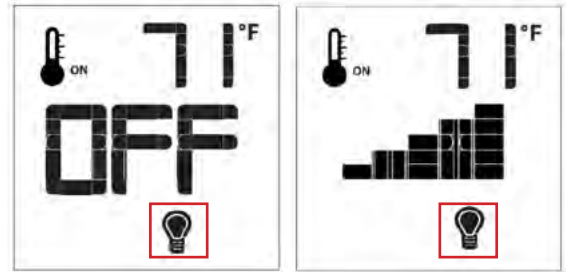

Figure 19.5.09:

Room Thermostat (Remote Operation)

The Remote Control can operate as a room thermostat. The thermostat can be set to a desired temperature to control the comfort level in a room.

To activate this function:

- Press the Thermostat Key. The LCD display on the remote will change to show that the room thermostat is "ON" and the set temperature is now active
- To adjust the temperature, press the Up/Down Arrow Keys until the desired temperature is displayed

Note: The fan will automatically activate 5min after ignition and shut down 12min after fire is turned off.

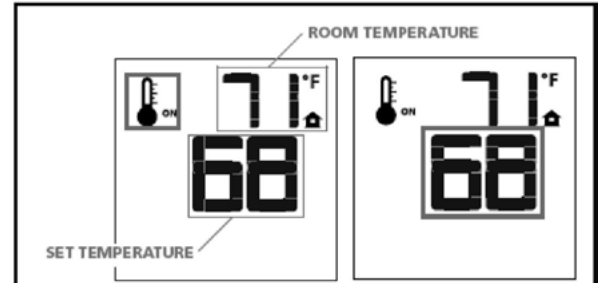

Figure 19.5.10:

SMART Thermostat (Remote Operation)

The Smart Thermostat function adjusts the flame height automatically in accordance to the difference between the set point and the actual room temperature. As the room temperature approaches the set point, the Smart Function will modulate the flame down.

To activate this function:

- Press the Thermostat Key until the word "SMART" appears to the right of the temperature bulb graphic
- To adjust the set temperature, press the Up/Down Arrow Keys until the desired set temperature is displayed

NOTE

When the fireplace is started in Smart Thermostat mode:

1. The fan will automatically activate 5min after ignition and shut down 12min after fire is turned off.
2. Manual Flame height adjustment is disabled.

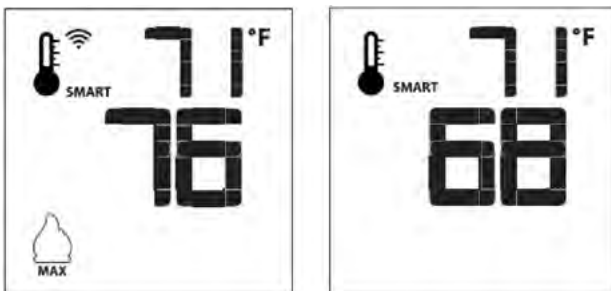

Figure 19.5.11:

Continuous Pilot on Demand / Intermittent Pilot (CPI/IPI) Selection

With the system in “OFF” position press the Mode Key to index to the CPI mode icon. Pressing the UP Arrow Key will activate the Continuous Pilot on Demand Ignition mode (CPI). Pressing the Down Arrow Key will return to IPI. A single “beep” will confirm the reception of the command.

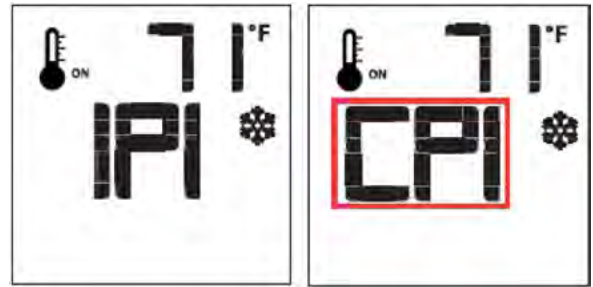

Figure 19.5.12:

CPI vs IPI:

Continuous Pilot on Demand Ignition (CPI): In this mode the pilot runs continuously even when the main burner is off. The Continuous Pilot on Demand Ignition operates on a seven day cycle. If the main burner is not turned on for seven continuous days, the pilot will turn itself off. When the main burner is lit again the cycle repeats. The pilot will remain lit for seven days, even after the main burner is turned off. If the main burner is lit during a seven day timing cycle, the seven day timer will reset.

Intermittent Pilot Ignition (IPI): A fuel saving mode in which the pilot is only used when the main burner is on.

This appliance is shipped in IPI mode. IPI mode is often the preferred method, however, there are some situations where it may be preferable to switch the fireplace into CPI mode. For example, in colder climates the glass door or the front of the fireplace could become very cold to the touch. Dynamic Start Advantage will solve most problems experienced by older IPI operated fireplaces.

Automatic Safety Shut-Off

This system will execute an automatic turn OFF command after a 24hr continuous main burner flame ignition. This allows the system to verify correct safety functions.

Diagnostic Indications Information

LOW BATTERY CONDITION (Less than 4V):

Remote Control

- Battery Icon will appear on LCD remote control display. Replace batteries.

Battery Back-up

- Red LED indicator will enter a (1) blink sequence. IFC Module will emit a double-beep when it receives an ON/OFF command from the hand held remote. Replace batteries.

Pilot Flame Error Condition:

- Red LED Indicator will commence a (2) blink sequence. Contact your dealer if this occurs.

System Lock Out Condition:

- Red LED Indicator will commence a (3) blink sequence. Make sure your gas is turned on.
- Make sure pilot sensor is not shorted out.
- If the system is in a locked state, reset the IFC module as follows: Turn off all power to the IFC module for at least 2 seconds (including the backup battery pack), then restore power to the IFC module.

Key Lock

This function will lock the keys to avoid unsupervised operation.

- To activate this function, press the MODE and UP Keys at the same time
- To deactivate this function, press the MODE and UP Keys at the same time

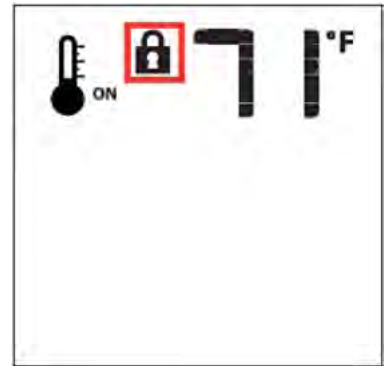

Figure 19.5.14:

Low Battery Power Detection (Less than 4V)

Remote

The life span of the remote control batteries depend on various factors:

- Quality of the batteries used
- The number of ignitions of the appliance
- The number of changes to the room temperature set point, etc

When the Remote batteries are low, a Battery Icon will appear on the LCD display of the Remote before all battery power is lost. When the batteries are replaced this Icon will disappear.

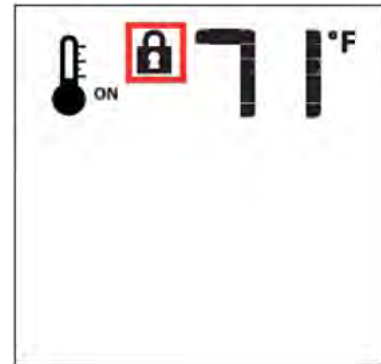

Figure 19.5.15:

BACKUP BATTERY PACK (used when 120V home electrical power is interrupted):

- Red LED indicator on the IFC Module will enter a (1) blink sequence
- Backup batteries lifespan depends on various factors including battery quality, number of ignitions, changes to room thermostat set point, etc. When batteries are low, a double beep will be emitted from the IFC control module when it receives an ON/OFF command from the remote control
- This is an alert for a low battery condition of the backup batteries and after this double-beep warning, no commands will be accepted until batteries are replaced
- When batteries are replaced a beep will be emitted from IFC control module as soon as powered

20.0 Maintenance

CAUTION:

Do not conduct maintenance on the appliance while it is operating or while it is still hot. Always verify proper operation after servicing.

20.1 Cleaning the Appliance

The exterior painted surfaces, glass, and metal plated trims may be cleaned with a soft, non-abrasive cloth and water or a suitable, mild, non-abrasive cleaner. Be sure there are no fingerprints left on the glass panels as high temperatures can bake these prints on permanently.

Regularly:

- Frequent cleaning of the ceramic glass is recommended. We recommend using a good quality ammonia free gas fireplace glass cleaner that is available at any hearth retail location. Take care to avoid scratching glass while cleaning. **DO NOT CLEAN WHILE HOT.** Never use common household cleaners to clean the glass.
- Keep the appliance area free from combustible materials, such as paper, wood, clothing, gasoline and flammable solids, liquids and vapors
- Visually check the height and color of the burner and pilot flames
- Touch up the paint if necessary using a high temperature metallic black paint

Once a year, have a qualified service technician:

- Perform the regular services listed above
- Inspect and operate the pressure relief mechanism (door buckles) to verify they are free from obstruction and operate properly
- Carefully remove the logs and gently brush off any loose carbon deposits. This job is best done outside the house, wearing a dust mask. The logs are very fragile, take care not to break them. Do not wash logs with any liquid. While the logs are removed, check that all burner openings are not obstructed and it is recommended you use a vacuum cleaner to clean off any dust or lint
- After cleaning, the logs and embers must be replaced according to the instructions in this manual
- Vacuum and clean any lint accumulations or debris in the firebox, on the burners, on the pilot, at the primary air opening, on the convection air blower and in any combustion and convection air passageways
- Inspect the operation of the flame safety system pilot and gas valve
- Inspect and ensure the lighting of the main burner occurs within 4 seconds of the main gas valve opening. Flames should match those shown in **Figure 20.5.01**
- Completely inspect the appliance and the venting system, if the vent pipe or seal is found to be defective, replace and or reseal (follow the instructions found in the venting instructions, **Section 13.0**)
- Inspect the condition of the vent and vent terminal for sooting or obstruction and correct if present
- Test and measure the flame failure response time of the flame safety system. It must de-energize the safety shutoff in no more than 30 seconds
- Check all accessible gas-carrying tubes, connections, pipes and other components for leaks

WARNING: All parts removed or disturbed, including guards and grills, must be properly replaced after maintenance. Service and repair must be conducted by a qualified service person. If these instructions are not followed, a fire or explosion may result, causing property damage, personal injury or loss of life.

20.2 Servicing Under Warranty

Before servicing, read the terms and conditions of the warranty at the back of this manual. Contact the authorized Ambiance dealer where you purchased the appliance from and provide them with details of the problem, along with the initial installation information (from the front of this manual).

WARNING: Servicing of this appliance **must be conducted by a qualified Archgard service technician**. Improper servicing, adjustment or alteration of this appliance may cause property damage, personal injury or loss of life. All servicing should be conducted with the appliance cold. All replacement parts must be authorized by Ambiance for suitability.

20.3 Checking Inlet and Outlet Pressure

1. Remove the surround.
2. The pressure test taps are located on the valve's front face. The inlet is marked 'IN' and the outlet is marked 'OUT'. See **Figure 20.3.01**.
3. Loosen the set screw inside the tap with a screwdriver.
4. Connect a 1/4" (6 mm) rubber tube to the tap post and a manometer.
5. Verify that the readings obtained are within specs (as shown on the appliance rating plate)
6. Be sure to tighten the set screw inside the tap after you have finished taking pressure readings.
7. Check for leaks.

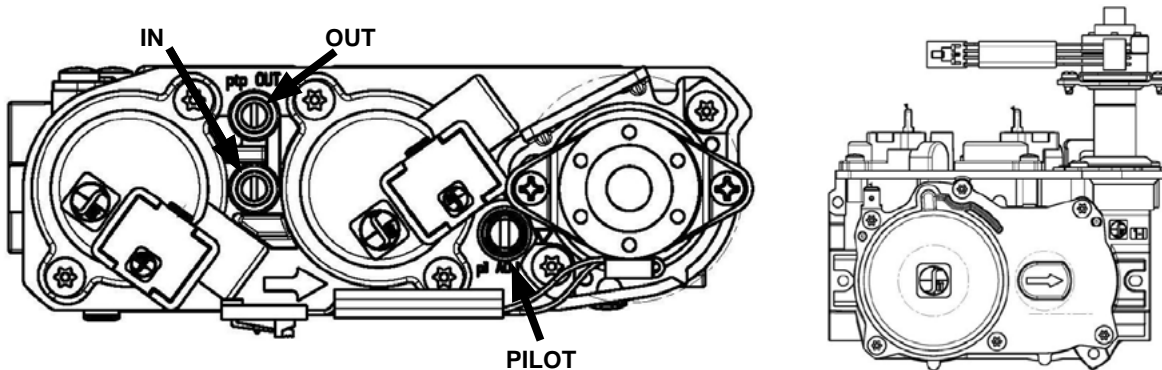

Figure 20.3.01

20.4 Checking and Adjusting Pilot

The pilot flames should have the characteristics shown in the illustration to the right.

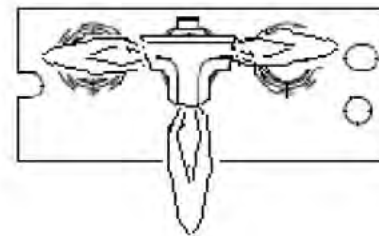

Figure 20.4.01

The flame should not have yellow tips but should engulf the flame sensor and spark electrode. It can be adjusted by turning the screw marked "pilot" on the control valve (See **Figure 20.3.01**).

It may be necessary to remove the pilot cover for a better view of the pilot flame (see next page).

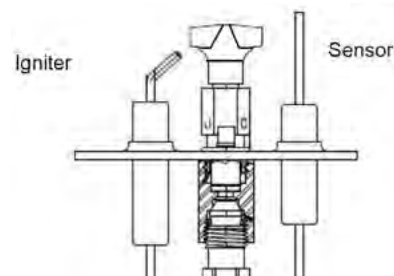

Figure 20.4.02

Removing the Pilot Cover

1. Before servicing, ensure gas and power supplies are OFF.
2. Remove the surround (recommended - see **Section 14**).
3. Remove the barrier screen (see **Section 15**).
4. Remove the door assembly (see **Section 16**).
5. Remove the burner media (see **Section 18**).
6. Remove log burner baffle (UF0600 ONLY - see **Figure 20.4.03**).
7. Remove the pilot cover (see **Figure 20.4.04**).
8. Installation is the reverse of removal.

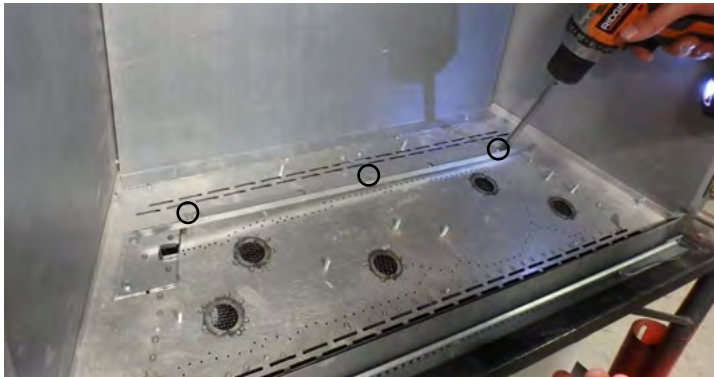

Figure 20.4.03: Log Burner Baffle (UF0600 ONLY)



Figure 20.4.04:

20.5 Adjusting the Primary Air

The UF0600 / UF0610 includes an air shutter located under the door of the fireplace which may be used to adjust the primary air to achieve the ideal flame as shown in **Figure 20.5.01**. To adjust, use a screwdriver to turn the air shutter adjustment screw as shown in **Figure 20.5.02**. To open the air shutter and increase air flow to the burner, turn the adjustment screw clockwise. To close the air shutter and decrease air flow to the burner, turn the adjustment screw counterclockwise.

CAUTION: Do not adjust primary air below specified opening on the rating plate.

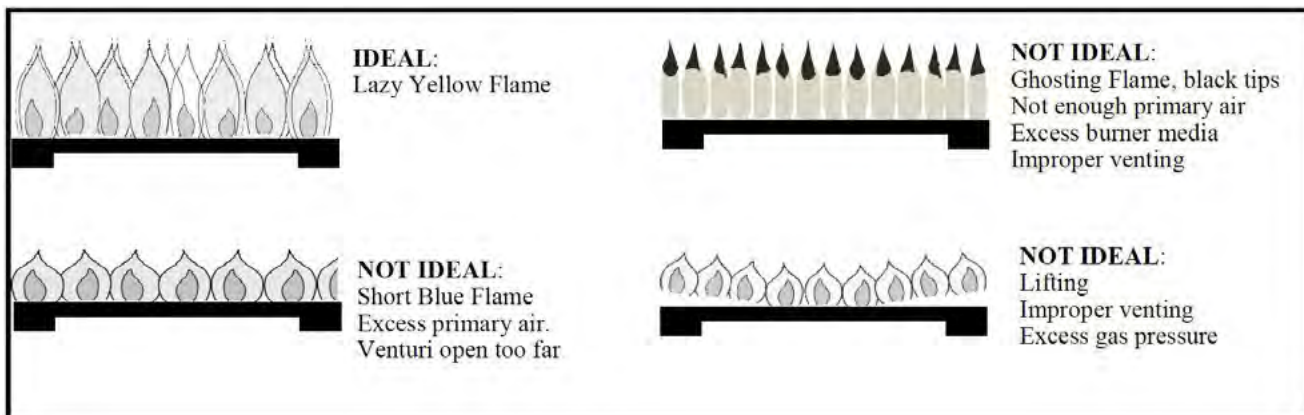

Figure 20.5.01:



Figure 20.5.02:

20.6 Replacing Batteries

1. Disconnect power supply to the fireplace.
2. Ensure the fireplace is off and cool before servicing.
3. Remove the fireplace surround.
4. Slide the control board outward. Do not over-extend the wires. See **Figure 20.6.01**.
5. Undo the velcro strap retaining the battery holder. See **Figure 20.6.02**.
6. Replace the batteries. See **Figure 20.6.03**.
7. Secure the battery holder in the velcro strap.
8. Slide the control board back in place. Be sure wires are not pinched. Wires should be neat and tidy.
9. Replace the surround and resupply power.
10. Light the fireplace to verify proper operation.

Battery Specifications: 4 x AA Batteries

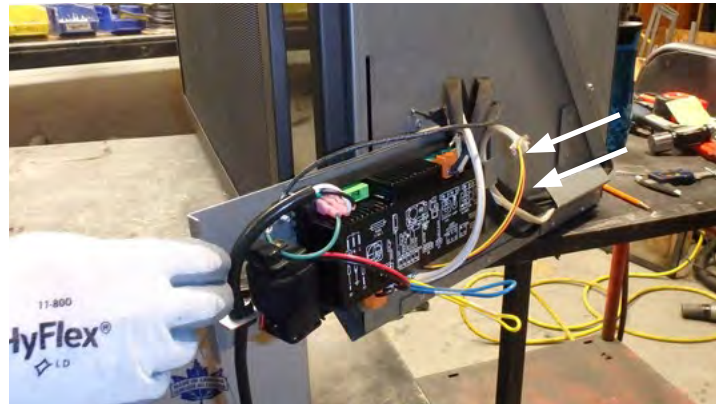

Figure 20.6.01:

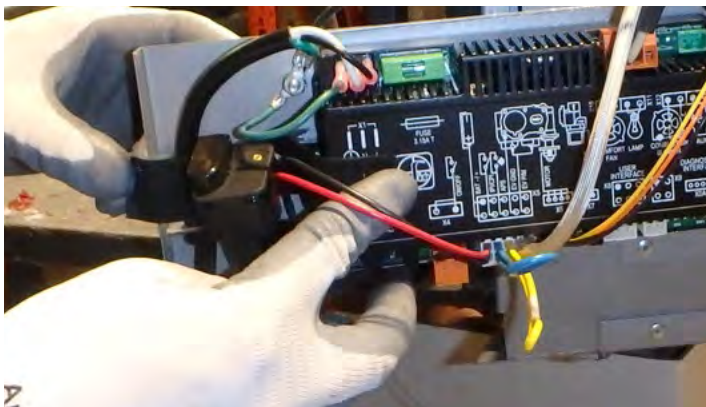

Figure 20.6.02:

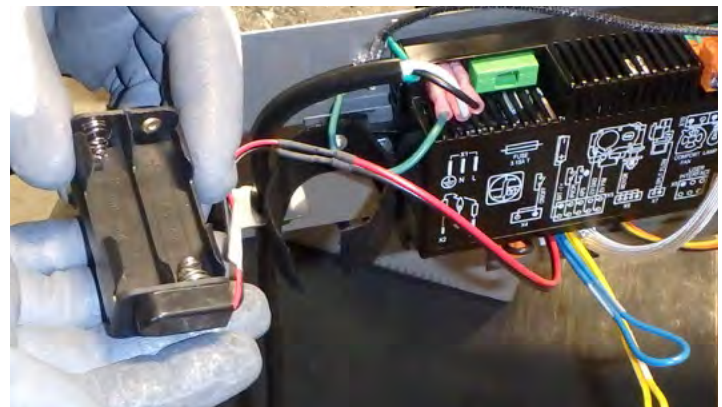

Figure 20.6.03:

20.7 Replacing Fuse

1. Disconnect power supply to the fireplace.
2. Ensure the fireplace is off and cool before servicing.
3. Remove the fireplace surround.
4. Slide the control board outward. See **Figure 20.7.01**.
5. Use pliers to gently pry the fuse from the control board. See **Figure 20.7.02**.
6. Replace the fuse with one which has the same specifications using the existing fuse holder.
7. Slide the control board back in place ensuring the wires are not pinched. Wires should be neat and tidy.
8. Replace surround and resupply power.
9. Light the fireplace to verify proper operation.

Fuse type: T3.15AL250V.
Part Number: RP-305-2080

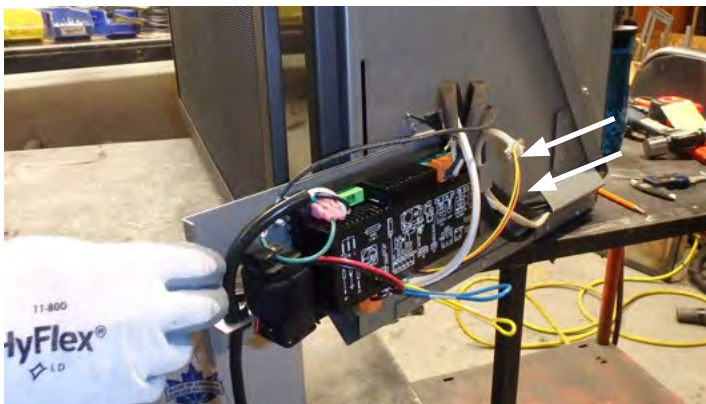

Figure 20.7.01:

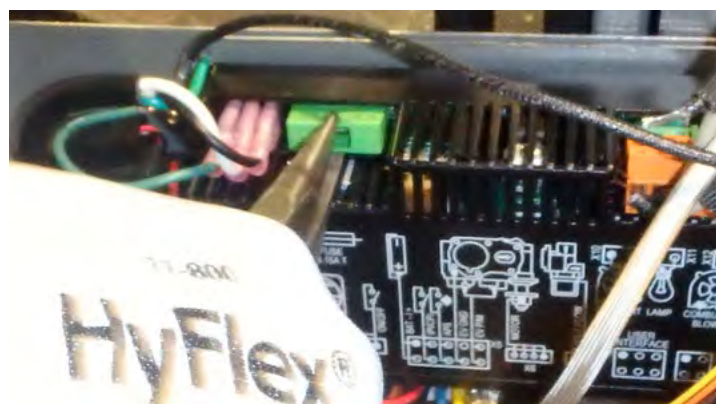

Figure 20.7.02:

20.8 Replacing Light Bulbs

Caution: Always handle bulbs with cotton gloves as finger prints may reduce the life of the bulb. We recommend replacing both bulbs at the same time.

1. Ensure the fireplace is off and cool before servicing.
2. Disconnect power supply to the fireplace.
3. Turn off gas supply.
4. Remove the fireplace surround (optional).
5. Remove the barrier screen. See **Section 14.0**.
6. Remove the door assembly. See **Section 15.0**.
7. Lights are located in the top of the firebox at the front edge. See **Figure 20.8.01**.

8. Pull the bulb to remove. See **Figure 20.9.02**.
9. Replace with a bulb of the same specifications.
10. Ensure burner media has not been disturbed.
11. Replace door, barrier screen, and surround.
12. Resupply gas and power.
13. Light the fireplace to verify proper operation. See **Section 19.5** for information on using the remote to control the lights.

Bulb specification:	120V / 20W
	G6.35
	HALOGEN



Figure 20.8.01:



Figure 20.8.02:

20.9 Replacing the Control Board

CAUTION: Label all wires prior to disconnection when servicing controls. Wiring errors can cause improper and dangerous operation. Verify proper operation after servicing.
 This appliance, when installed, must be electrically grounded in accordance with local codes or, in the absence of local codes, with the **National Electrical Code, ANSI/NFPA 70, or the Canadian Electrical code, CSA C22.1.**

Before you begin:

- Ensure the fireplace is off and cool before servicing.
- Disconnect power supply to the fireplace.
- Remove the fireplace surround.

Step 1: Slide the control board outward.

Step 2: Unplug the four-pin connector.

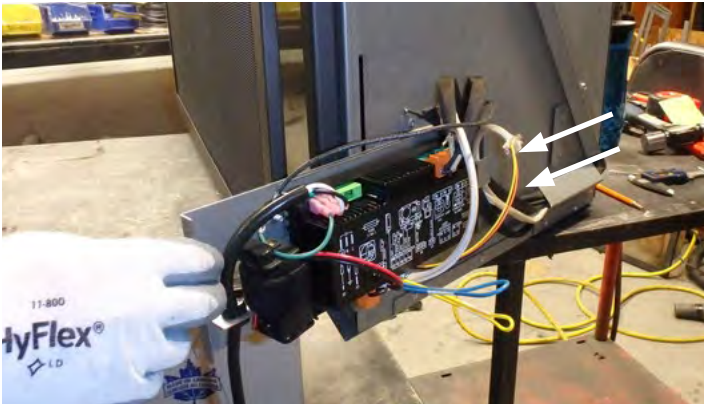

Figure 20.9.01:

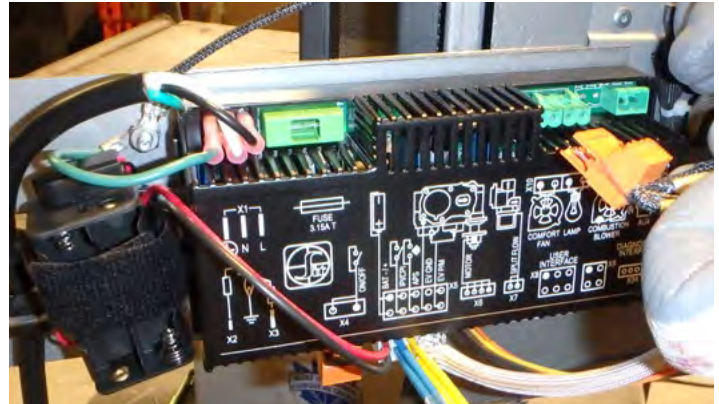

Figure 20.9.02:

Step 3: Unplug the black valve wire.

Step 4: Unplug the white eight-pin connector.

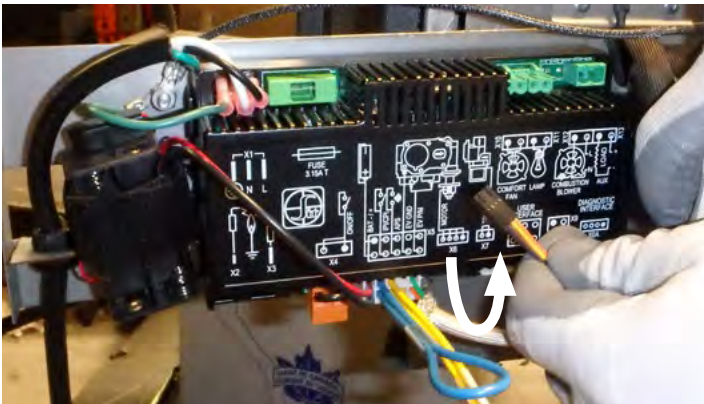

Figure 20.9.03:

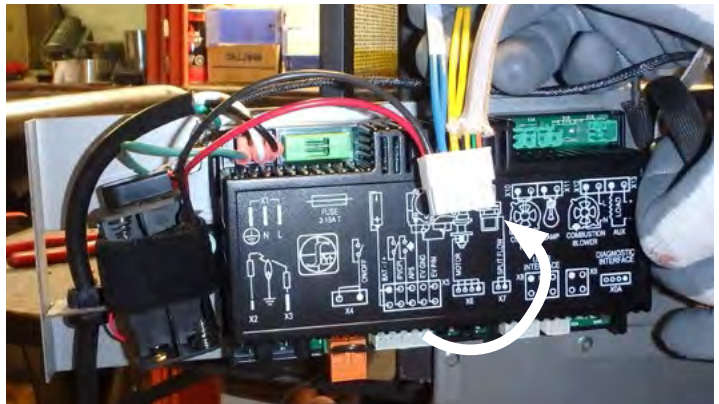

Figure 20.9.04:

Step 5: Unplug the power wires.

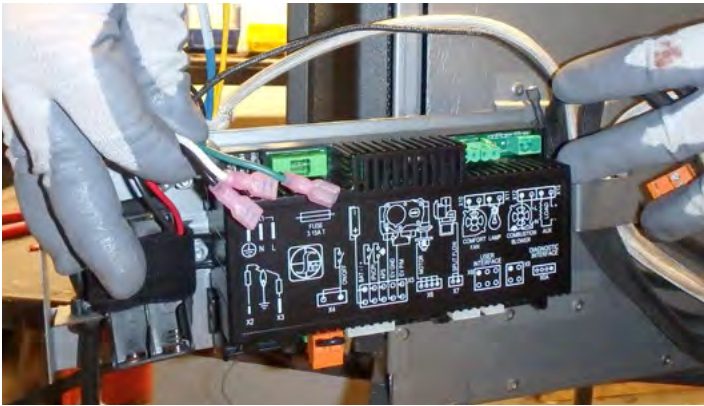

Figure 20.9.05:

Step 6: Unplug and retain the ON/OFF Override jumper.

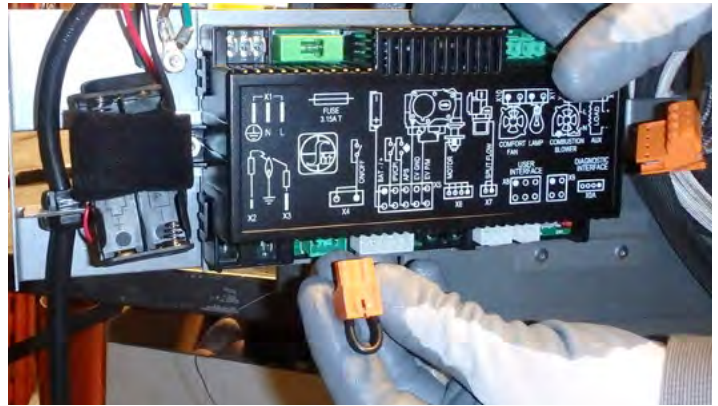

Figure 20.9.06:

Step 7: Remove nuts retaining the control board.

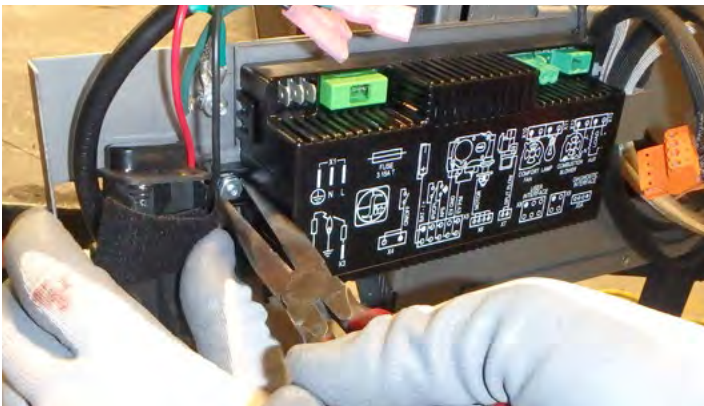

Figure 20.9.07:



Figure 20.9.08:

Step 8: Replace with the new control board using nuts removed from the old board.

Step 9: Plug all connectors into the new board.

Step 10: Slide the control board back in place ensuring the wires are not pinched. Wires should be neat and tidy.

Step 11: Replace surround and resupply power.

Step 12: Sync the fireplace remote to the new control board. See Section 19.5 and Figure 20.9.09.

Step 13: Light the fireplace to verify proper operation.

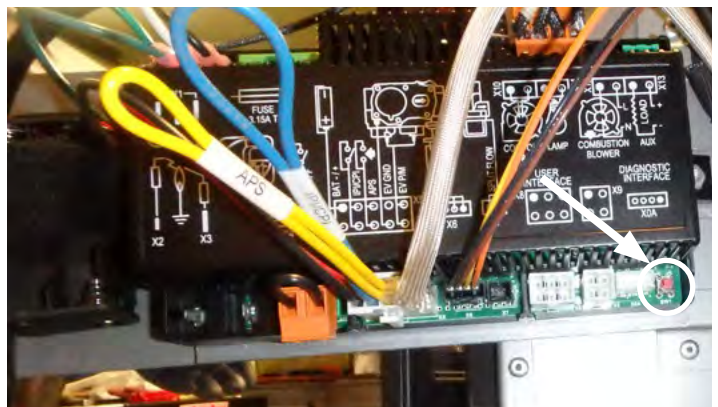

Figure 20.9.09: Remote Sync Button

20.10 Replacing the Burner

Recommended tools: needle nosed pliers / accessory hook / flathead (slot) screwdriver.

Before you begin:

- Ensure the fireplace is off and cool before servicing
- Disconnect power supply to the fireplace
- Turn off gas supply
- Remove the fireplace surround
- Remove barrier screen. See **Section 15.0**.
- Remove door assembly. See **Section 16.0**.
- Remove burner media. See **Section 18**.
- Remove panel set (if applicable). See **Section 17**.

Step 1: Remove 2 tek screws securing the masking plate. Pull the bottom of the plate forward to disengage the top, then tilt the top outward to remove.

Step 2: Remove 7 tek screws securing the burner.

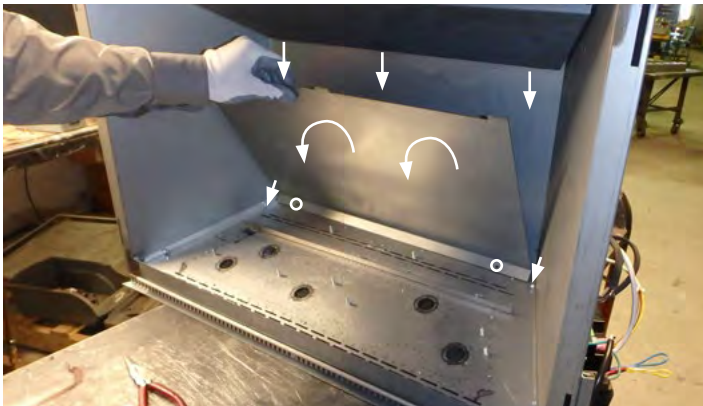

Figure 20.10.01:

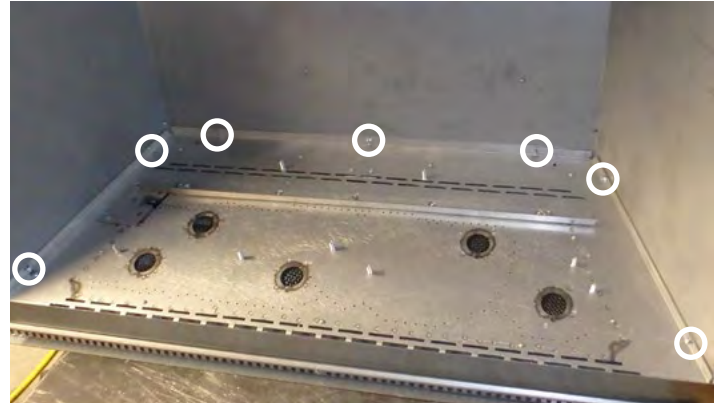

Figure 20.10.02:

Step 3: Carefully lift burner out and away from the fireplace. Install the new burner by aligning the mixing tube in the air shutter.

Step 4: Lift the front of the burner over the lip on the front of the firebox and allow it to drop down inside the firebox. Move the burner back in place.



Figure 20.10.03:

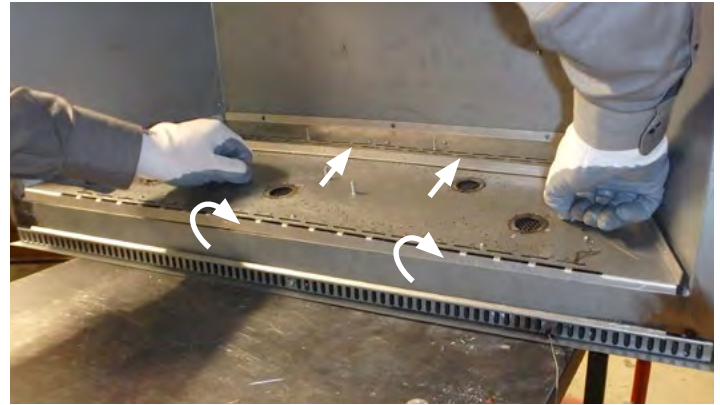

Figure 20.10.04:

Step 5: Loosely reinstall the tek screws along the back of the burner.



Figure 20.10.05:

Step 6: Loosely install the tek screws at the front of the burner. Use a set of needle nosed pliers, accessory hook, or flathead (Slot) screwdriver if necessary to lift the burner. Take care to avoid damage to the burner.



Figure 20.10.06:

Step 7: Loosely install the tek screws on the rear sides of the burner. Tighten all screws.



Figure 20.10.07:

Step 8: Reinstall the masking plate by inserting at an angle, rotating the top inward, and pressing down to insert the upper tabs in the top of the firebox. Secure with 2 tek screws previously removed.



Figure 20.10.08:

Step 9: Reinstall the panel set (if applicable), burner media, door assembly, barrier screen, and fireplace surround (see relevant sections).

Step 10: Turn on gas supply and reconnect power supply. Light the fireplace to verify proper operation.

20.11 Replacing the Pilot

Recommended tools: Stubby 1/4" hex driver.

Before you begin:

- Ensure the fireplace is off and cool before servicing.
- Disconnect power supply to the fireplace.
- Turn off gas supply.
- Remove the fireplace surround.
- Remove barrier screen. See **Section 15.0**.
- Remove door assembly. See **Section 16.0**.
- Remove burner media. See **Section 18**.
- Remove panel set (if applicable). See **Section 17**.
- Remove the burner. See **Section 20.10**.
- Loosen the vent slider assembly to allow the fireplace to slide out of the fireplace opening. See **Section 13.2**.

Step 1: Remove the 9 tek screws securing the rear panel of the fireplace.



Figure 20.11.01:

Step 2: Cut the two zip ties securing the wires in the back of the fireplace.



Figure 20.11.02:

Step 3: Remove the pilot line from the valve located on the left side of the fireplace (if necessary, pilot line sold separately).



Figure 20.11.03:

Step 4: Remove the short cable cover located on the right side of the fireplace.

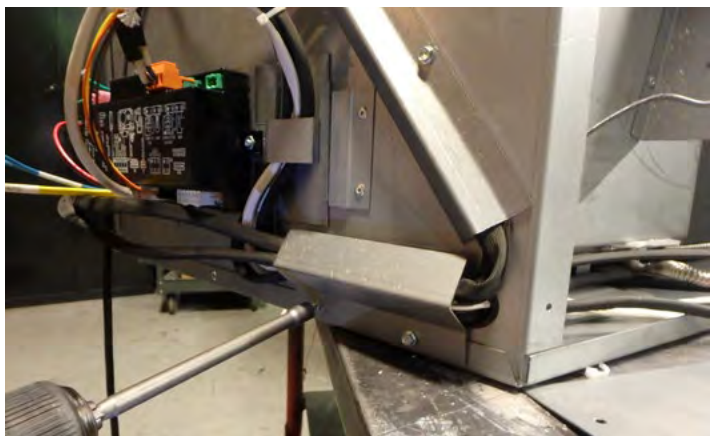

Figure 20.11.04:

Step 5: Cut the zip tie securing the cables connected to the control box.



Figure 20.11.05:

Step 7: Unplug the remaining pilot wires.

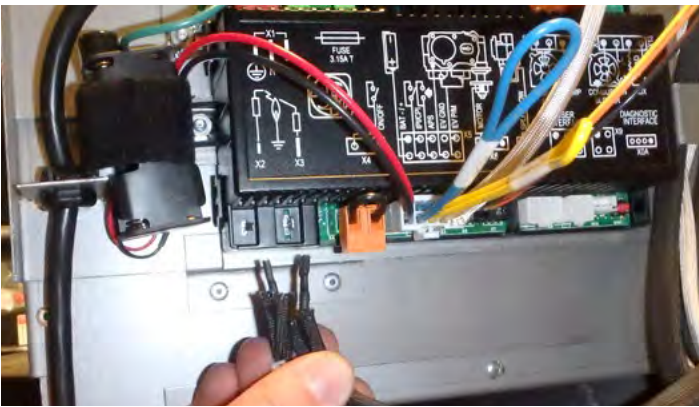

Figure 20.11.07:

Step 9: Remove the pilot from the extrusion. If using the existing pilot gas line, disconnect the pilot gas line from the pilot.

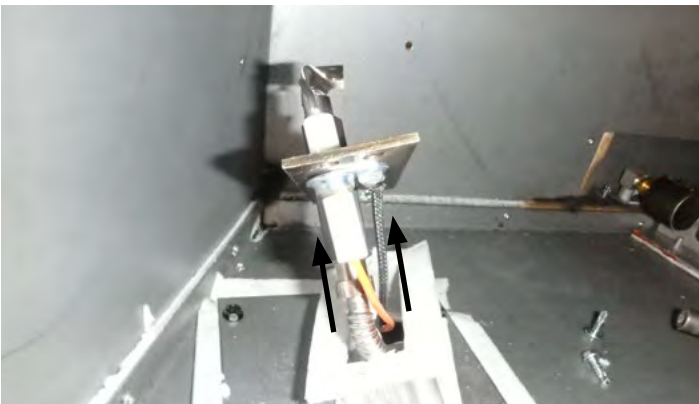

Figure 20.11.09:

Step 6: Remove the nut securing the black ground wire from the pilot.

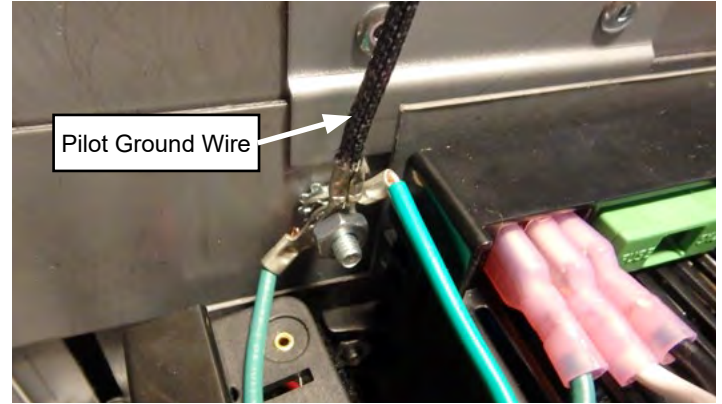

Figure 20.11.06:

Step 8: Remove the screws securing the pilot to the pilot extrusion or, if necessary, remove the entire assembly.

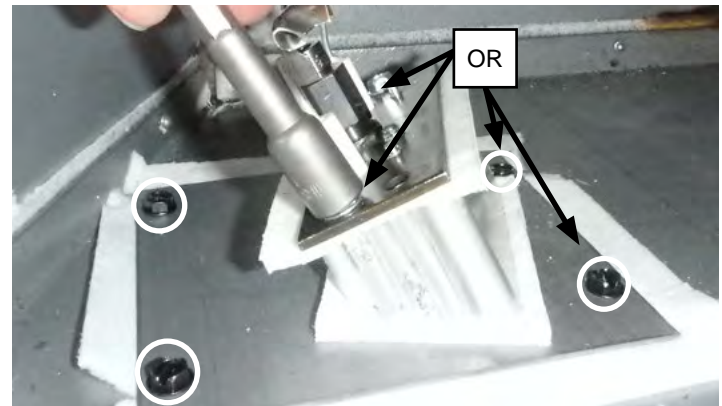

Figure 20.11.08:

Step 10: Installation of the pilot is the reverse of removal. Replace the gasket when installing (sold separately). When reinstalling, be sure to route the pilot wires around the leveling bolt as shown.



Figure 20.11.10:

Step 11: Be sure to use zip ties to secure wires in the back of the fireplace in a tidy bundle. The wires should not be pressed against the back of the firebox but should not be pushed forward where they will obstruct airflow. Always trim the ends of zip ties.



Figure 20.11.11:

Step 12: Be sure to use zip ties to secure wires on the left side of the fireplace in a tidy bundle. Always trim the ends of zip ties.



Figure 20.11.12:

Step 13: Repeat for the wires at the control board and route wires through the bracket. See **Figure 20.11.05**.

Step 14: Bundle the valve motor wires and secure to the pilot gas line using a zip tie. See **Figure 20.11.12**.

Step 15: Reinstall the back plate and short cable cover (do not pinch wires during install). Slide the fireplace back into the fireplace opening.

Step 16: Reinstall the vent slider plate using a new gasket (purchased separately).

Step 17: Reinstall the burner, panel set (if applicable), burner media, door assembly, barrier screen, and fireplace surround (see relevant sections).

Step 18: Turn on gas supply and reconnect power supply.

Step 19: Light the fireplace to verify proper operation and adjust pilot as necessary according to **Section 20.4**.

20.12 Replacing the Fan

CAUTION: Label all wires prior to disconnection when servicing controls. Wiring errors can cause improper and dangerous operation. Verify proper operation after servicing.
 This appliance, when installed, must be electrically grounded in accordance with local codes or, in the absence of local codes, with the **National Electrical Code, ANSI/NFPA 70, or the Canadian Electrical code, CSA C22.1.**

Before you begin:

- Ensure the fireplace is off and cool before servicing.
- Disconnect power supply to the fireplace.
- Turn off gas supply.
- Remove the fireplace surround.
- Remove barrier screen (recommended). See **Section 15.0**.
- Remove door assembly (recommended). See **Section 16.0**.
- Remove burner media (recommended. See **Section 18**.
- Slide the fireplace from the fireplace opening, removing the vent slider plate as you do. See **Section 13.2** for the operation of the vent slider plate.

Step 1: Remove the back panel of the fireplace by removing 10 tek screws.

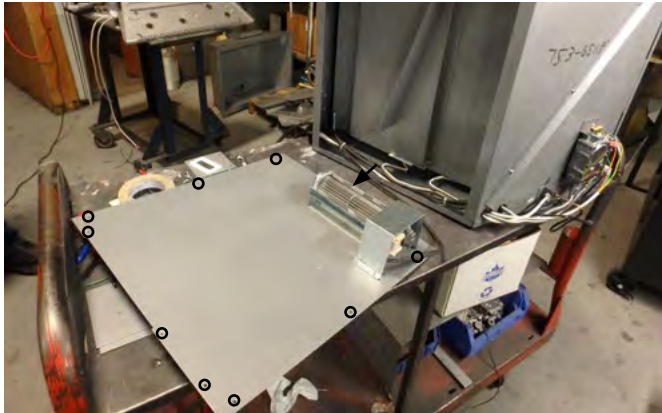

Figure 20.12.01:

Step 2: Unplug the wires from the fan.

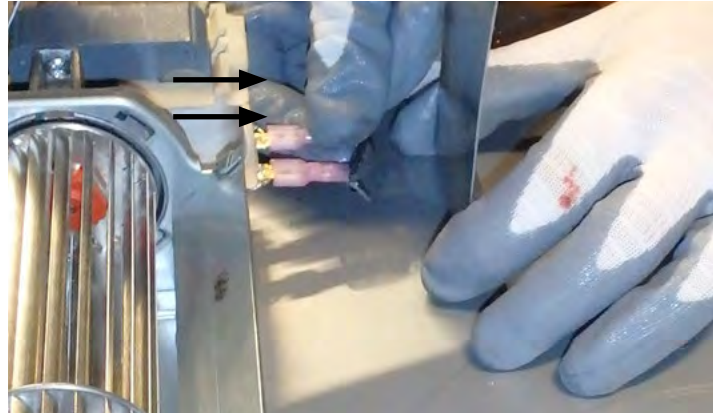

Figure 20.12.02:

Step 3: Remove the 3 tek screws that attach the fan to the rear panel.

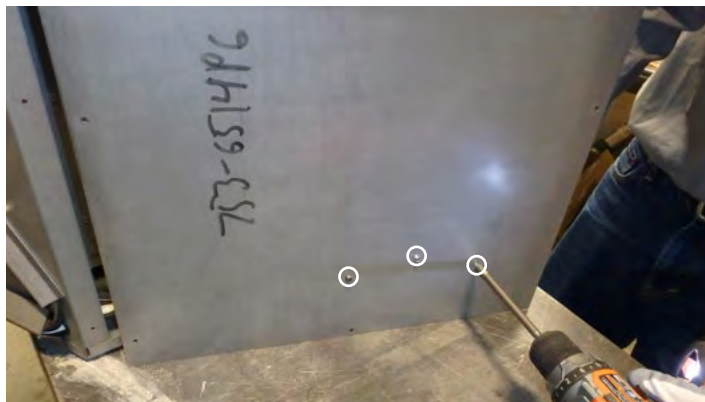

Figure 20.12.03:

Step 4: Remove the old fan.



Figure 20.12.04:

Step 5: Plug the fan wires into the new fan.

Step 6: Align the new fan with the mounting holes on the rear panel as shown.

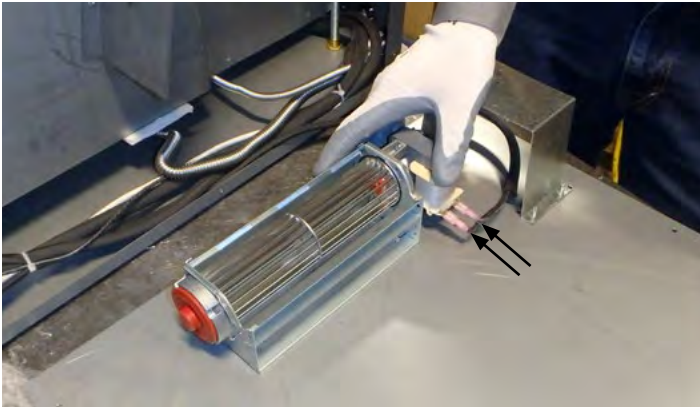

Figure 20.12.05:

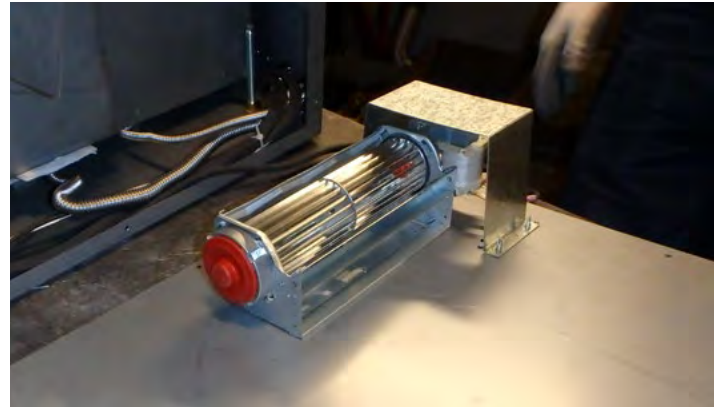

Figure 20.12.06:

Step 7: Verify operation of the fan by temporarily supplying power (do not resupply gas yet) and testing the fan.

Step 8: Reinstall the rear panel with the tek screws previously removed.

Step 9: Place the fireplace back into the opening while reinstalling the vent slider plate. Be sure to use a new gasket when reinstalling the vent slider plate (gasket purchased separately).

Step 10: Reinstall the burner media, door assembly, barrier screen, and fireplace surround (see relevant sections).

Step 11: Turn on gas supply and reconnect power supply.

Step 12: Light the fireplace to verify proper operation.

20.13 Replacing Light Bases

The steps below describe the process for replacing a light in the UF0600 or UF0610. The process is identical no matter which light is being replaced.

Note: we recommend replacing both light bulbs when replacing the light bases.

Before you begin:

- Ensure the fireplace is off and cool before servicing.
- Disconnect power supply to the fireplace.
- Turn off gas supply.
- Remove the fireplace surround.
- Remove barrier screen. See **Section 15.0**.
- Remove door assembly. See **Section 16.0**.
- Remove burner media. See **Section 18**.
- Remove panel set (if applicable). See **Section 17**.
- Remove light bulbs. See **Section 20.8**.
- Loosen the vent slider assembly to allow the fireplace to slide out of the fireplace opening. See **Section 13.2**.

Step 1: Remove three tek screws that secure the long cable covers on the left and right sides of the fireplace (three per cover).

Step 2: Unplug light wiring as shown.



Figure 20.13.01:

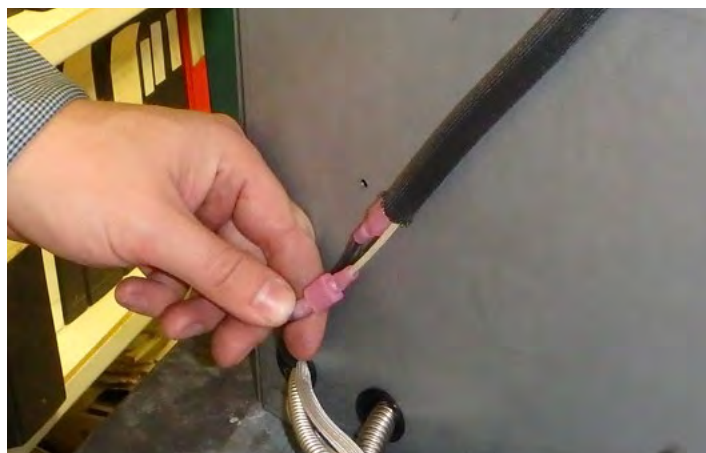

Figure 20.13.02:

Step 3: Remove four screws securing the lights (four per light). See **Figure 20.13.03**. When removing screws be sure to retain the light bracket shown in **Figure 20.13.04**.



Figure 20.13.03:



Figure 20.13.04:

Step 4: Remove the light.

Step 5: Route the wires through the access hole as shown.

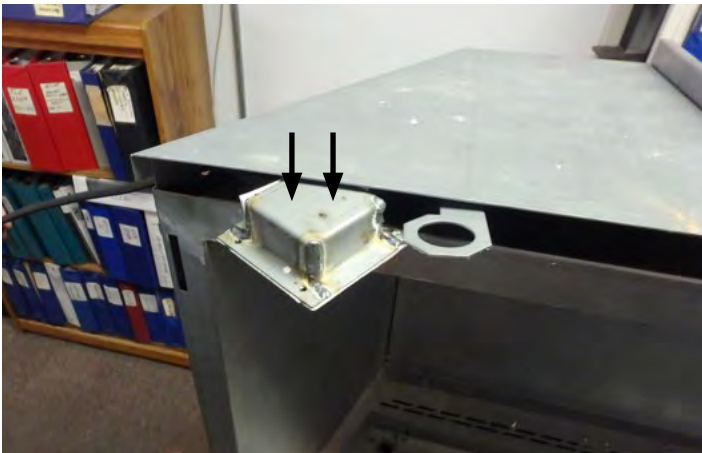

Figure 20.13.05:



Figure 20.13.06:

Step 6: Route the new light wires and install the new light using the screws removed in Step 3.

Step 7: Reinstall the long cable cover (do not pinch wires during install). Slide the fireplace back into the fireplace opening.

Step 8: Reinstall the light bulbs and check the lights by temporarily supplying power (do not resupply gas yet) and testing the lights.

Step 9: Reinstall the vent slider plate using the a new gasket.

Step 10: Reinstall the burner, panel set (if applicable), burner media, door assembly, barrier screen, and fireplace surround (see relevant sections).

Step 11: Turn on gas supply and reconnect power supply.

Step 12: Light the fireplace to verify proper operation.

20.14 Wiring Schematic

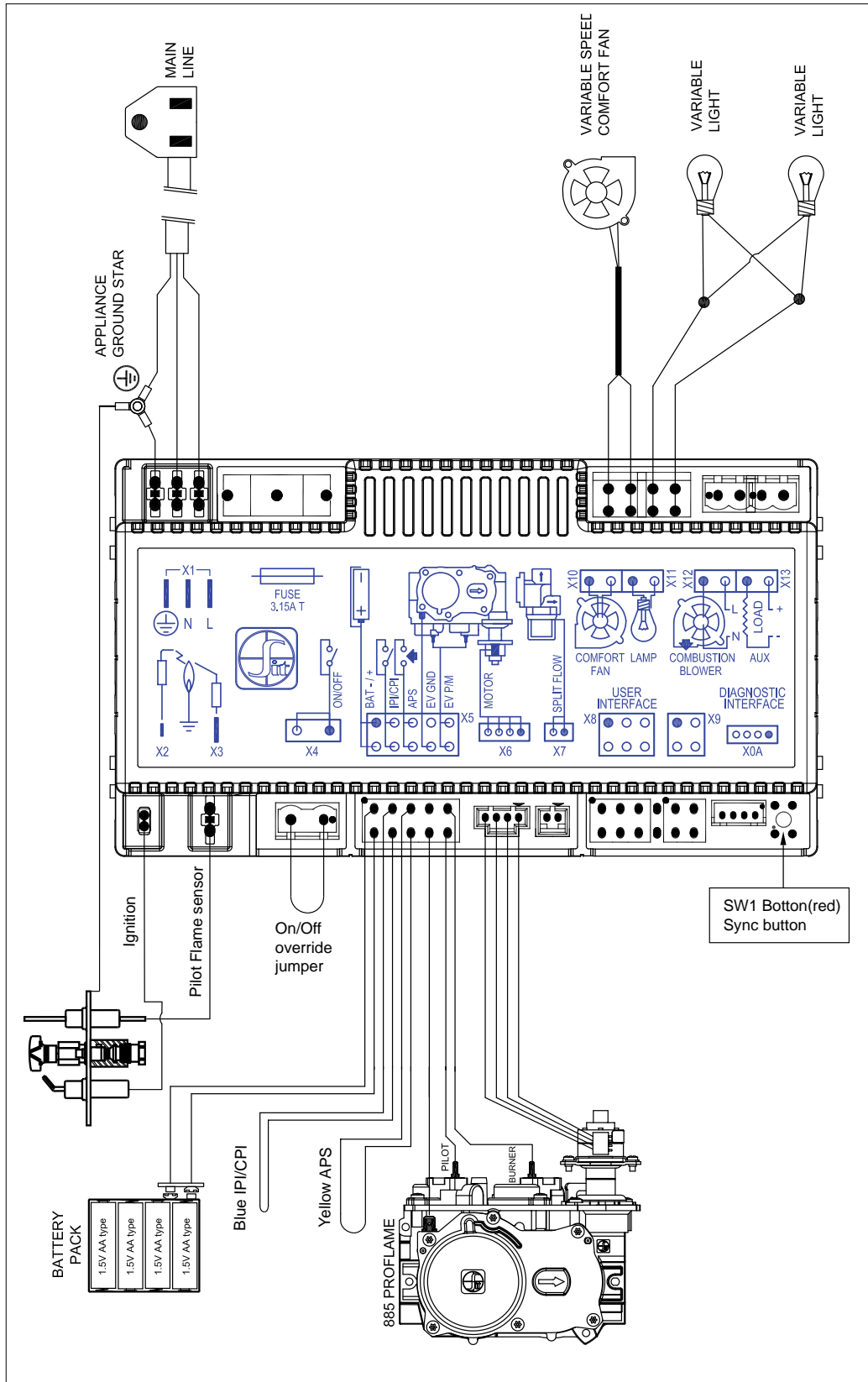

Figure 20.14.01

20.15 Troubleshooting

Issue	Solution
The pilot igniter won't spark.	<ol style="list-style-type: none"> 1. Ensure the ON/OFF override jumper is installed correctly. 2. Ensure main power is ON and new batteries are installed in the remote control (3 x AAA) and backup battery pack on the control board (4 x AA). 3. Make sure remote is synced with control board. 4. Check the 3.15A fuse in the control board. Replace the fuse if necessary. 5. Make sure remote is not in smart or thermostat mode. 6. Ensure igniter wire is connected to the control board and is not damaged.
The pilot igniter sparking, but the pilot will not light.	<ol style="list-style-type: none"> 1. Verify the inlet gas pressure is within acceptable limits. 2. Check all connections to the gas valve. 3. Ensure fuel supply valves and emergency shut-off valve are open. 4. Check wiring connections from control board to valve. 5. Check that the pilot is set to the correct fuel. 6. Ensure pilot head is clear of debris.
The pilot lights, but the main burner will not light.	<ol style="list-style-type: none"> 1. Check and verify all wiring connections match the wiring diagram. 2. Verify the inlet and manifold pressure are within acceptable limits.
The pilot lights, but the main burner will not light and igniter continues to spark.	<ol style="list-style-type: none"> 1. Check the pilot flame sensor rod and clean with steel wool or similar if dirty. 2. Check the pilot hood and clean with steel wool if dirty. 3. Ensure the flame sensor wire is plugged into the control board and is not damaged. 4. Adjust pilot flame using the pilot adjustment screw if the pilot flame is too long or too short (the flame should fully engulf the sensor rod and must be stable). 5. Check supply pressure. 6. Ensure the ground wire from the pilot is connected to the fireplace ground location.
The pilot was lit but will randomly go out.	<ol style="list-style-type: none"> 1. Turn the fireplace on again. If the fireplace is in continuous pilot on demand ignition mode, the system will turn off the pilot if the fireplace has not been used for seven days. You may also switch the fireplace to IPI mode (See Section 19.5). 2. Have a service technician check for low inlet pressure.
The flames on the main burner are low even though the remote is on high.	<ol style="list-style-type: none"> 1. Wait two minutes. Dynamic Start Advantage is designed to build a draft by starting on low and automatically increasing the flame size to the setting on the remote after two minutes. This system helps to create a better flame appearance, reduce condensation on the glass, and provide years of carefree operation. 2. Have a service technician check for low inlet pressure. 3. Replace the valve motor.
Fans do not work.	<ol style="list-style-type: none"> 1. Ensure main power is ON and the fireplace is plugged in (the fireplace may be operating on back up batteries). 2. Check the 3.15A fuse in the control board and replace if necessary. 3. Ensure the fans are connected to the control board.
Lights do not work.	<ol style="list-style-type: none"> 1. Ensure main power is ON and the fireplace is plugged in (the fireplace may be operating on back up batteries). 2. Check the 3.15A fuse in the control board and replace if necessary. 3. Ensure the lights are connected to the control board. 4. Replace the bulbs (bulbs may be burnt out).
Control module beeps twice when On/Off button on remote is pressed and Red LED is On.	<ol style="list-style-type: none"> 1. Replace batteries in remote battery pack.

All service and repairs should be performed by a qualified and licensed service technician.

21.0 Frequently Asked Questions

Listed below are some frequently asked questions regarding Ambiance Gas Fireplaces. If you have questions that are not listed below, or are not answered in this manual, please contact your Authorized Ambiance Dealer.

Q. My glass has a condensation “fog” when the appliance is first lit.

A. Condensation is normal and will disappear in a few minutes after the glass is heated. This can be reduced if the appliance is left in CPI mode.

Q. I have a white “film” on my glass. What is the best way to clean the inside of the glass.

A. Frequent cleaning of your glass is recommended. We recommend using a good quality “gas fireplace” glass cleaner that is available at all authorized dealers. Do not use abrasive materials, and do not clean the glass or the appliance when the unit is hot.

Q. How do I care for my plated trims.

A. We recommend a cleaning with a damp cloth. DO NOT use chemical cleaners as they may harm the finish, and void your warranty.

NOTE: If the top louvers, or top overlay starts to discolor, check the door gasket seal and contact your local Ambiance dealer to replace if necessary.

Q. My fan/blower makes a “whirring” or “humming” noise.

A. Your Ambiance gas appliance uses a powerful fan to push heated air into your room. It is not unusual to hear a “humming” noise when your fan is running. Note: the sound will change depending on the setting that your fan speed control is set at.

Q. I hear a “ticking”, “cracking” or “pinging” sound when my fireplace is running, and after it is turned off.

A. The different gauges of steel used to manufacture your fireplace will expand and contract at different rates when your fireplace is on, and will continued as your fireplace completes its heating function. You will likely hear these same sounds more on start up and shut down. This is normal for steel fireplaces.

Q. I hear a “click” when my main burner turns ON or OFF.

A. Your Gas Control Valve will make a clicking sound when it opens to allow gas to flow to the main burner. This is a normal part of the operating system.

Q. Can I burn wood and other materials in my gas fireplace.

A. No! Burning anything other than the fuel (natural gas or propane) the fireplace is setup for will create a potential fire hazard and present a danger to your home and its occupants and possibly void your manufacturer's warranty. Only burn the gas fuel for which the unit was originally designed.

Q. Can I shut my pilot off in the summer?

A. You will save energy by turning off the pilot light if you are not using your appliance for the hot summer months. When in continuous pilot ignition on demand (CPI) mode the pilot will remain lit for seven days after the fireplace is used. When seven days have passed the system will turn the pilot off. When in IPI mode, the pilot will only remain on when the main burner is on.

Q. Why does my fireplace start with a low flame? Shouldn't the flame size match the remote setting?

A. Dynamic Start Advantage was designed to create a draft by starting the fireplace on low and automatically increasing the flame to match the remote setting after two minutes. This system helps to create a better flame appearance, reduce condensation on the glass, and provide years of carefree operation.

Q. Can I position my gas logs in a different fashion or use a different log set?

A. No. Your gas fireplace is an engineered system that includes the firebox, burner, logs, venting and options which are tested and listed with a certification agency. Changing any specifications or placement of the logs could cause injury or damage, void your manufacturer's warranty, and possibly even your homeowner's warranty.

22.0 Replacement Parts List

Item #	Item Description	Unit
200-0600-12	Installation, Operation, and Maintenance Manual - English	EA
200-0600F-12	Installation, Operation, and Maintenance Manual - French	EA
URP-891-0200	Barrier Screen	EA
308-6060	SIT Proflame II Dynamic Start Advantage with Continuous Pilot on Demand	EA
308-6022	Handheld Remote	EA
308-6024	Wall Mount Remote	EA
308-6027	SIT 885 Gas Valve c/w Step Motor (0-885-009)	EA
305-6002-R1	Module Main Wiring Harness (5 wire)	EA
305-6003-R1	Valve Wiring Harness (4 wire)	EA
305-0060	Battery Back-up	EA
RP-305-2080	Fuse, 3.15A, 250V (Pack of 5)	EA
301-0068-31	Orifice - #31 DMS for Natural Gas	EA
301-0068-47	Orifice - #47 DMS for Propane	EA
308-0124	Pilot Assembly	EA
308-0125	PSE Spark Ignighter	EA
308-0126	PSE Flame Sensor	EA
314-0139	Pilot Gasket	EA
301-6242	Pilot Gas Line	EA
URP-891-0040	Burner Assembly - Log Burner (UF0600)	EA
URP-891-0060	Burner Assembly - Contemporary Burner (UF0610)	EA
URP-891-0180	Light Base	EA
305-6314	Light Bulb (120V / 20W / G6.35)	EA
UA1500	Conversion Kit LP to NG	EA
UA1400	Conversion Kit NG to LP	EA
314-0170	Flue Slider Gasket	EA
RF-305-0624	Replacement Fan	EA
UA0003	Kentucky Oak 7pcs Log Set c/w black embers	SET
UA0004	Eastern Township Birch 7pcs Log Set c/w black embers	SET
URP-891-0000	Complete Replacement Door. Includes glass, gasket and door frame	EA

Warranty

Limited Warranty

This Limited Warranty is made by ARCHGARD INDUSTRIES LTD., hereinafter referred to as "Archgard". Archgard warrants to the original purchaser of an Archgard gas burning fireplace(s) that the product will be free from defects in materials and workmanship under normal use and service, for a "lifetime". All warranty repairs are to be performed by an authorized Archgard Dealer during the warranty period. Other repair / service company charges for any work done during the warranty period, will be the responsibility of the home owner.

INCLUSIONS: "LIFETIME LIMITED WARRANTY"

- All heat exchangers and combustion chamber
- Ceramic Fiber Logs and Ceramic Brick Panels, against splitting and cracking due to heat exposure

NOTE: Discoloration and some minor movement including warping of certain parts are normal and are not a defect; therefore, not covered under warranty.

INCLUSIONS: "TEN YEAR LIMITED WARRANTY"

- Burner tubes and pans

INCLUSIONS: "TWO YEAR LIMITED WARRANTY"

- Ceramic Glass against thermal breakage
- Trims and accessories from splitting or separating
- Electronic Control Module, Remote Transmitter

Items included with the two-year and ten-year limited warranty will be covered under "Parts & Subsidized Labour" to the original purchaser for one (1) year and "Parts Only" thereafter from original date of purchase.

INCLUSIONS: "ONE YEAR LIMITED WARRANTY"

- Blowers, fans and fan motors, wiring, rheostats and therm-discs
- Rocker switches, spill switches and wiring to them
- Gas control valves, pilot assemblies including thermopiles, thermocouples, electrodes and igniters
- Paint peeling or cracking

Items included with the one-year limited warranty will be covered under "Parts & Subsidized Labour" to the original purchaser for one (1) year from date of purchase.

WHAT TO DO IN THE EVENT OF A PROBLEM:

- Thoroughly read your "Owner's Installation, Operation & Maintenance Manual"
- If you cannot solve the problem, contact your Archgard dealer or representative
- When calling for assistance, please have the following information:
 - **Model of your fireplace**
 - **Serial Number**
 - **Place of Purchase**
 - **Date of Purchase**
 - **Problem Description**

NOTE: Warranty will be void if work is carried out by an unqualified person(s). Only original Archgard parts may be used. Please consult your Archgard dealer or representative if in doubt about a replacement part(s).

- All warranty repairs are to be performed by an authorized Archgard Dealer during the warranty period. Other repair / service company charges for any work done during the warranty period, will be the responsibility of the home owner.

OBTAINING WARRANTY SERVICE:

The original purchaser shall return the defective part(s) to the original authorized Archgard dealer – transaction prepaid, along with the serial number of the appliance and original proof of purchase. Any defective part, in our judgment, will be repaired or replaced at Archgard's discretion. The dealer must obtain approval from Archgard before any repairs are made.

WARRANTY LIMITATION:

THIS LIMITED WARRANTY IS MADE IN LIEU OF ALL OTHER WARRANTIES, EXPRESSED OR IMPLIED AS TO QUALITY, MERCHANTABILITY OR FITNESS FOR PARTICULAR PURPOSE.

The appliance is only warranted for the use as intended by the installation and operating instructions and local building codes. The warranty will not cover damage due to accident, misuse, abuse, alteration, improper installation or "Acts of God". This limited warranty is void unless the appliance is installed by a qualified Archgard installer, in accordance with the instructions furnished with the appliance. Some Provinces or States do not allow limitations on how long an implied warranty lasts, so the above limitations may not apply to the original purchaser. Any damage resulting from defects in this product is limited to the replacement of the defective part(s) and does not include incidental and consequential exposures sustained in connection with the product. This includes facing(s), mantle(s), cabinet(s), tile(s) or any other finishes resulting from removal of any gas appliance. This warranty is limited to residential use only and gives the consumer specific rights. These rights may vary from State to State or Province to Province.

WARRANTY CONDITIONS & REQUIREMENTS:

1. You are the original purchaser – this warranty is not transferable.
2. Installation of the fireplace must be performed by a qualified Archgard installer.
3. Installation and operation must comply with the installation and operation instructions.
4. All optional accessories are covered for one (1) year from the date of purchase.
5. This warranty does not offer coverage for light bulbs or batteries (whether factory, dealer, or installer supplied). This includes any damage stemming from non-use.
6. Damage during shipping or handling of components, defects resulting from improper installation or service, or misuse of the fireplace or fireplace components are not covered under this warranty.
7. This warranty does not cover any part of the fireplace or any component which has been exposed to or submerged under water.
8. Archgard must be notified by the dealer the fireplace was purchased from or a qualified Archgard technician of the defect.
9. Annual service of the fireplace as required in the installation manual must be performed by a qualified Archgard technician (service records may be required to claim a warranty).
10. All previous warranty service must have been performed by a qualified Archgard technician (service records may be required to claim a warranty).
11. Travel time or mileage to the original purchaser's residence is not covered under this warranty. We suggest that you pre-arrange travel expenses with your Authorized Archgard Dealer.

POSTAGE

WARRANTY REGISTRATION

ARCHGARD INDUSTRIES LTD.
7116 BEATTY DRIVE
MISSION, B.C. CANADA
V2V 6B4

CUT ALONG LINE

FOLD DOWN AT LINE

CUT ALONG LINE

FOLD DOWN AT LINE & TAPE CLOSED

Model # : _____ Serial #: _____ Date Installed: _____ / _____ / _____

Name: _____ Address: _____

City: _____ State/Prov: _____ ZIP: _____ Phone: (_____) _____

Dealer's Name & Address: _____

City: _____ State/Prov: _____ ZIP: _____ Phone: (_____) _____

Installer's Name & Address: _____

City: _____ State/Prov: _____ ZIP: _____ Phone: (_____) _____

Why did you choose this product? _____

CUT ALONG LINE

Thank you for purchasing our product and filling out this warranty card. Save time by completing this form at www.archgard.com/warranty-registration

7116 BEATTY DRIVE
MISSION, B.C. V2V 6B4
CANADA