

# Amantii

---

## ELECTRIC FIREPLACES

### INSTALLATION AND OPERATION INSTRUCTIONS FOR

**INS-FM-30 / INS-AMB-30**

(INS-190030-01)

**INS-FM-34 / INS-AMB-34**

(INS-190030-01)



#### SAFETY INFORMATION



#### WARNING

**For your safety, always comply with all warnings and safety instructions contained in this manual to prevent personal injury or property damage.**

Do not store or use gasoline or other flammable vapors and liquids in the vicinity of this appliance.

**INSTALLER: LEAVE OWNER'S MANUAL WITH THE APPLIANCE.**

**CONSUMER: RETAIN OWNER'S MANUAL FOR FUTURE REFERENCE.**



**WARNING:** This product can expose you to chemicals including Lead in the wiring, which is [are] known to the State of California to cause birth defects or other reproductive harm. For more information visit: [www.p65warnings.ca.gov](http://www.p65warnings.ca.gov)



Version:20211111

# TABLE OF CONTENTS

Please read and carefully follow all of the instruction found in this manual. Please pay special attention to the safety instructions provided in this manual. The instructions included here will assure that you have many years of dependable and enjoyable service from your Amantii product.

IMPORTANT INSTRUCTIONS .....	3
FCC CAUTIONS .....	4
UNPACKING AND TESTING THE APPLIANCE .....	5
GROUNDING APPLIANCE .....	5
LOCATING THE FIREPLACE.....	5
INS-FM-30 / INS-AMB-30 (INS-190030-1) .....	6
INS-FM-34 / INS-AMB-34 (INS-190034-1) .....	7
INSTALLATION BUILT-IN.....	8
MANTEL CLEARANCE.....	9
HARDWIRE INSTALLATION .....	10
MEDIA OPTIONS .....	11
DECORATIVE MEDIA INSTALLATION.....	11
OPERATION.....	12
MANUAL OPERATION .....	12
REMOTE CONTROL OPERATION.....	13
WIFI OPERATION.....	16
REPLACEMENT PARTS.....	19
EXPLODED VIEW .....	20
WIRING DIAGRAM.....	21
TROUBLE SHOOTING.....	22
SERVICE HISTORY .....	23
WARRANTY .....	24

## **IMPORTANT INSTRUCTIONS**

PLEASE RETAIN THIS USER GUIDE FOR FUTURE REFERENCE

When using electrical appliances, basic precautions should always be followed to reduce the risk of fire, electric shock, and injury to persons, including the following:

- 1) Read all instructions before using this fireplace
- 2) The fireplace is hot when in use. To avoid burns, do not let bare skin touch hot surfaces. Keep combustible material such as furniture, cushions, bedding, paper, clothes, curtains at least 3 feet from the front of the unit
- 3) Extreme caution is necessary when any heater is used near children and whenever the unit is left operating and unattended.
- 4) Do not operate a fireplace with a damaged cord or plug, or if the heater has malfunctioned, the fireplace has drooped or damaged in any manner
- 5) Not all fireplaces are suitable for use in bathrooms or laundry facilities. Please consult with individual product literature to confirm suitability
- 6) Do not run the cord under carpeting. Do not cover cord with throw rugs, runners or the like. Arrange the cord away from traffic area and where it will not be tripped over
- 7) Do not modify this fireplace. Use it as described in the manual. Any other use not recommended by the manufacture may cause fire, shock or injury to persons
- 8) Do not use this heater with programmer, timer, separate remote-control system or any other device that switches the heater on automatically, since a fire risk exists if the heater is covered or positioned incorrectly
- 9) Disconnect all power supply before cleaning, maintenance or relocation of the fireplace
- 10) Keep the heater clean. Do not allow any objects to enter any ventilation or exhaust opening as this may cause electric shock, fire or damage to the heater
- 11) Do not immerse the cord, plug or any part of the appliance in water or any other liquid
- 12) In order to avoid a hazard due to inadvertent resetting of the thermal cut-out, this appliance must not be supplied through an external switching device

### **SAVE THESE INSTRUCTIONS**

**CAUTION:** Procedures and techniques, which, if not carefully followed, will result in damage to the equipment.

**WARNING:** Procedures and techniques, which, if not carefully followed, will expose the user to the risk of fire, serious injury, illness or death.

**Consult with professional electrician and adhere to all code requirements for installations in bathrooms**

## **FCC CAUTIONS**

This device complies with part 15 of the FCC Rules. Operation is subject to the following two conditions: (1) This device may not cause harmful interference, and (2) this device must accept any interference received, including interference that may cause undesired operation.

Any Changes or modifications not expressly approved by the party responsible for compliance could void the user's authority to operate the equipment.

Note: This equipment has been tested and found to comply with the limits for a Class B digital device, pursuant to part 15 of the FCC Rules. These limits are designed to provide reasonable protection against harmful interference in a residential installation. This equipment generates uses and can radiate radio frequency energy and, if not installed and used in accordance with the instructions, may cause harmful interference to radio communications. However, there is no guarantee that interference will not occur in a particular installation. If this equipment does cause harmful interference to radio or television reception, which can be determined by turning the equipment off and on, the user is encouraged to try to correct the interference by one or more of the following measures:

Reorient or relocate the receiving antenna.

Increase the separation between the equipment and receiver.

Connect the equipment into an outlet on a circuit different from that to which the receiver is connected.

Consult the dealer or an experienced radio/TV technician for help.

This equipment complies with FCC radiation exposure limits set forth for an uncontrolled environment. This equipment should be installed and operated with minimum distance 20cm between the radiator & your body.



## UNPACKING AND TESTING APPLIANCE

Carefully remove the appliance from the box.

Prior to installing the appliance, test to make sure the appliance operates properly by plugging the power supply cord into a 120 Volt grounded outlet.

Test all aspects of its operation (manual switches, remote and heater) to make sure all components are operating correctly.

As with most electronic devices, your new electric fireplace has been designed to operate at temperatures between 5 °C (41°F) and 35 °C (95°F). During the cold winter months, allow the fireplace to reach room temperature before turning it on.

**NOTE: There may be trace of odor during the first few minutes of initial use. This is harmless, normal and will never occur again.**

## GROUNDING APPLIANCE

This appliance is for use on 120 Volts. The cord has a plug as shown in (A). An adapter as shown in (C) is available for connecting three-blade grounding type plugs to two-slot receptacles. The green grounding lug extending from the adapter must be connected to a permanent ground such as a properly grounded outlet box. The adapter should not be used if a three-slot grounded receptacle is available.

To disconnect appliance, turn controls to off, then remove plug from outlet.

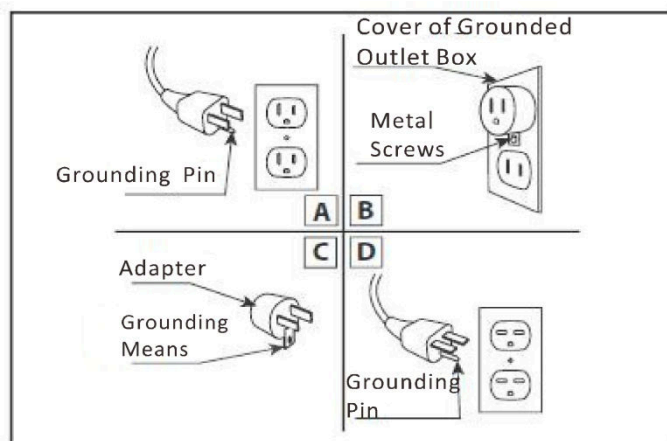

Note : Adaptor are NOT for use in Canada

## LOCATING THE FIREPLACE

Plan where to locate and frame the fireplace. This will save time and money later when you install the fireplace. Before installation consider the following:

1. Where the fireplace is located must allow for wall and ceiling clearances
2. Consider a location where the fireplace screen will not be exposed to direct sunlight from windows or doors.
3. A 15 ampere, 120 Volt, 60 Hz branch circuit with proper ground must be available at the location. Preferably a dedicated branch circuit should be provided to avoid circuit breakers to trip or fuses to blow.

# INS-FM-30/INS-AMB-30(INS-190030-01)

Description	Built-in Appliance
Voltage	120V AC 60Hz
Watts	1500W Max
NO HEATER	16.2W
MOTOR HEATER	19W
Appliance Width	29 3/8" or 74.6 cm
Appliance Height	19" or 48.2 cm
Appliance Depth	8 3/4" or 22.22 cm
Gross Weight	63.8lbs or 22.3kg
Plug Location	Left side
Cord Length	72.6" or 180 cm
Rough Wall Opening Size	31 3/8" x 19 7/8" or 79.7 cm x 50.5 cm
BTU	5118

This appliance has been tested in accordance with the UL Standard 2021 for fixed and location dedicated electric room appliances in the United States and Canada. If you need assistance during installation, please contact your local dealer.

NOTE: This appliance must be electrically wired and grounded in accordance with local codes. In the absence of local codes, use the current CSA C22.1 Canadian Electrical Code in Canada or the ANSI/NFPA 70 National Electrical Code in the United States.

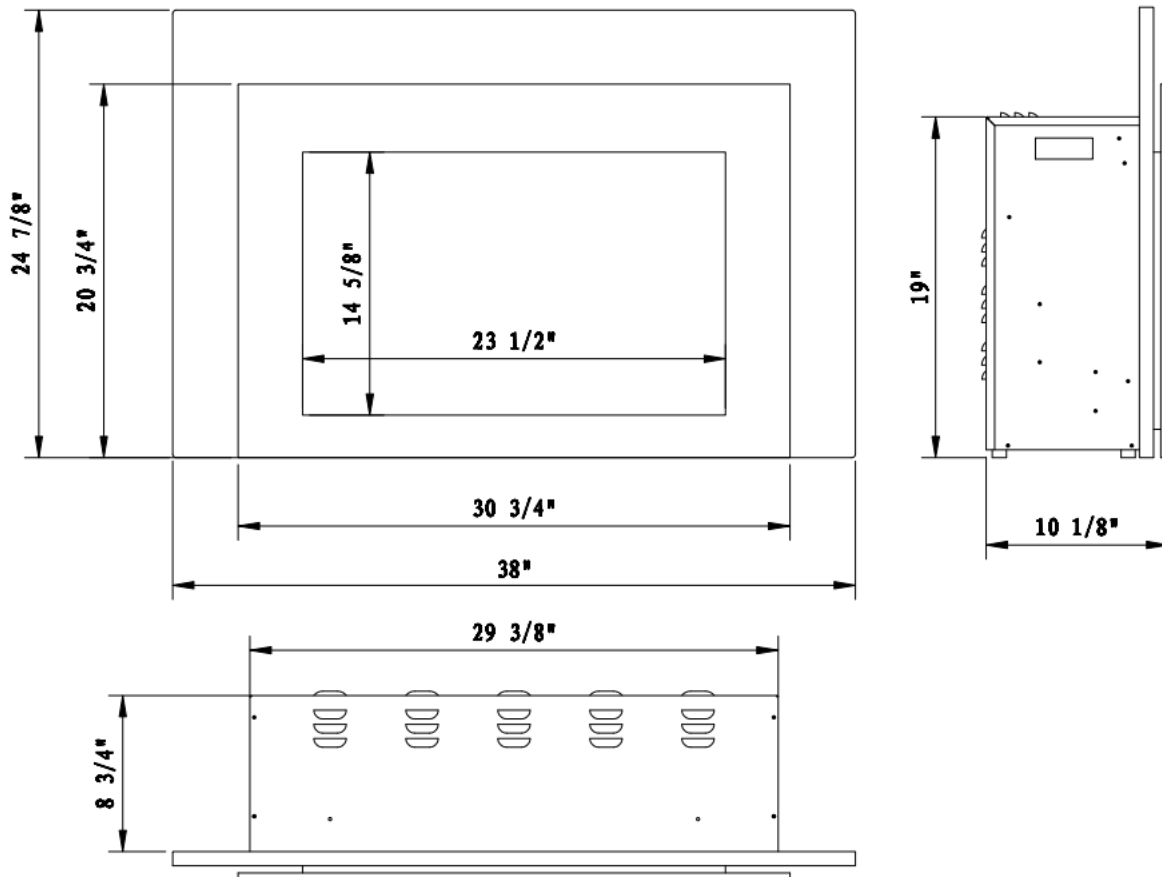

# INS-FM-34/INS-AMB-34(INS-190034-01)

Description	Built-in Appliance
Voltage	120V AC 60Hz
Watts	1500W Max
NO HEATER	20.5W
MOTOR HEATER	19W
Appliance Width	33 1/8" or 84.14 cm
Appliance Height	23 1/8" or 58.74 cm
Appliance Depth	8 3/4" or 22.22 cm
Gross Weight	77lbs or 33kg
Plug Location	Left side
Cord Length	72.6" or 180 cm
Rough Wall Opening Size	35 1/8"× 24" or 89.2 cm× 60.9 cm
BTU	5118

This appliance has been tested in accordance with the UL Standard 2021 for fixed and location dedicated electric room appliances in the United States and Canada. If you need assistance during installation, please contact your local dealer.

NOTE: This appliance must be electrically wired and grounded in accordance with local codes. In the absence of local codes, use the current CSA C22.1 Canadian Electrical Code in Canada or the ANSI/NFPA 70 National Electrical Code in the United States.

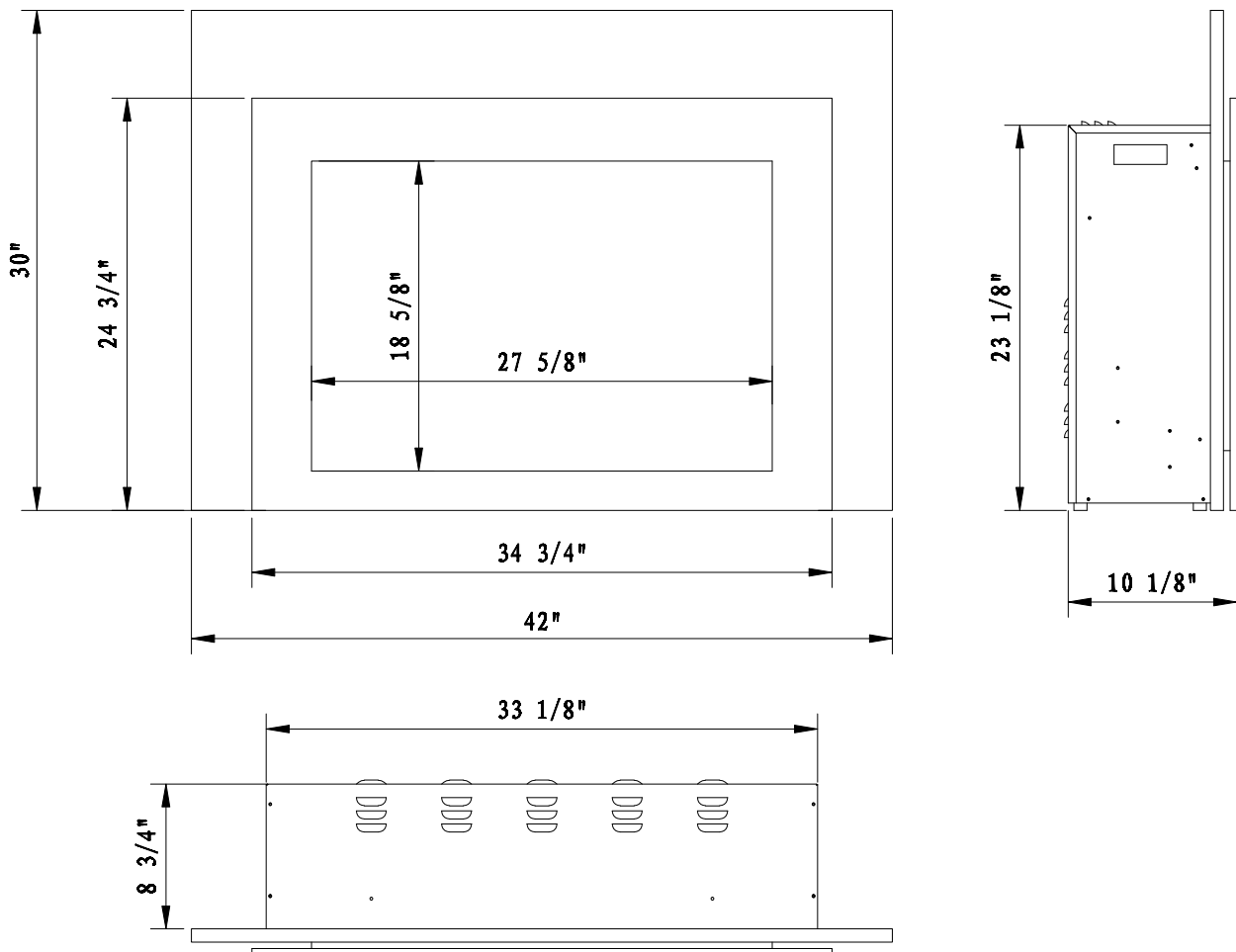

## INSTALLATION BUILT-IN

The fireplace may be placed within a framed enclosure that is level, dry and capable of supporting the weight of the appliance and front glass. It may be placed directly on wood or a non-combustible surface(not on linoleum or carpet).

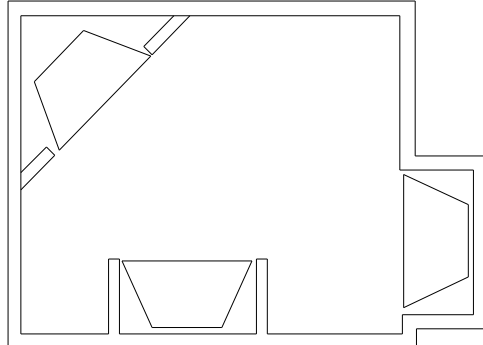

The side and back must maintain 1”(25.4mm) clearance to any material. The top must maintain a 3/8” (10mm) clearance to any material.

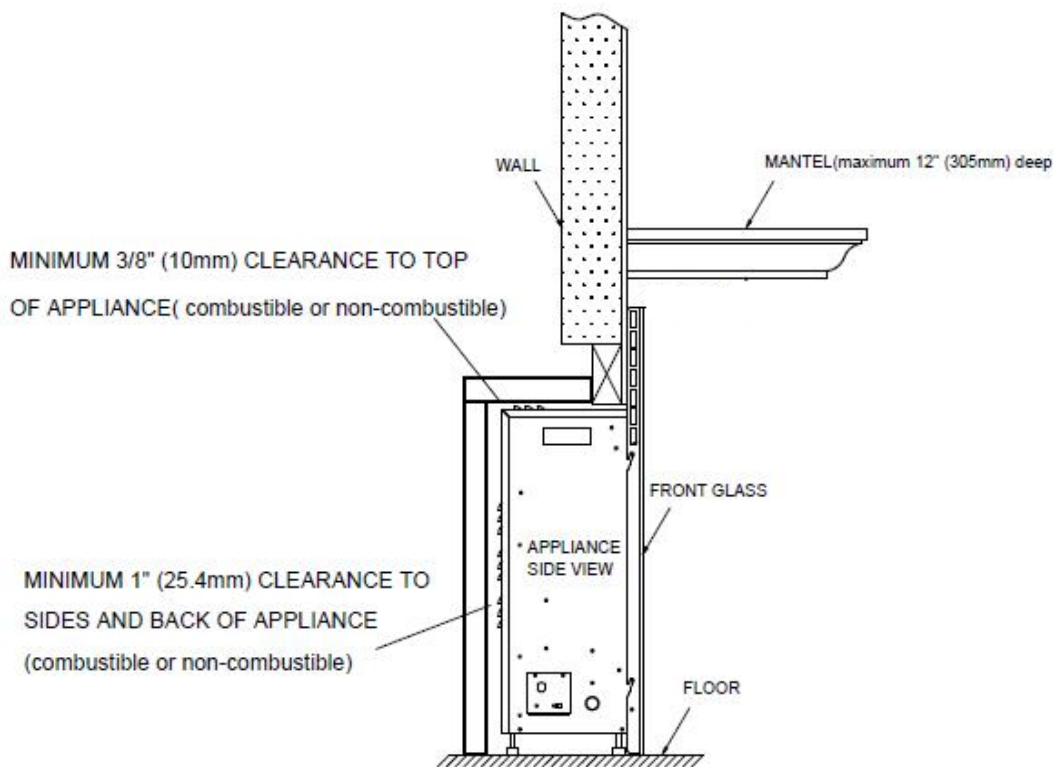

Ensure clearances to combustibles are maintained when building a mantel or shelves above the appliance. Elevated temperatures on the wall or in the air above the appliance can cause melting, discolorations or damage to decorations, a TV set or other electronic devices.

## MANTEL CLEARANCE

The clearance to the mantel should be 2" minimum when a mantel is applied (Measurement is taken from the trim).

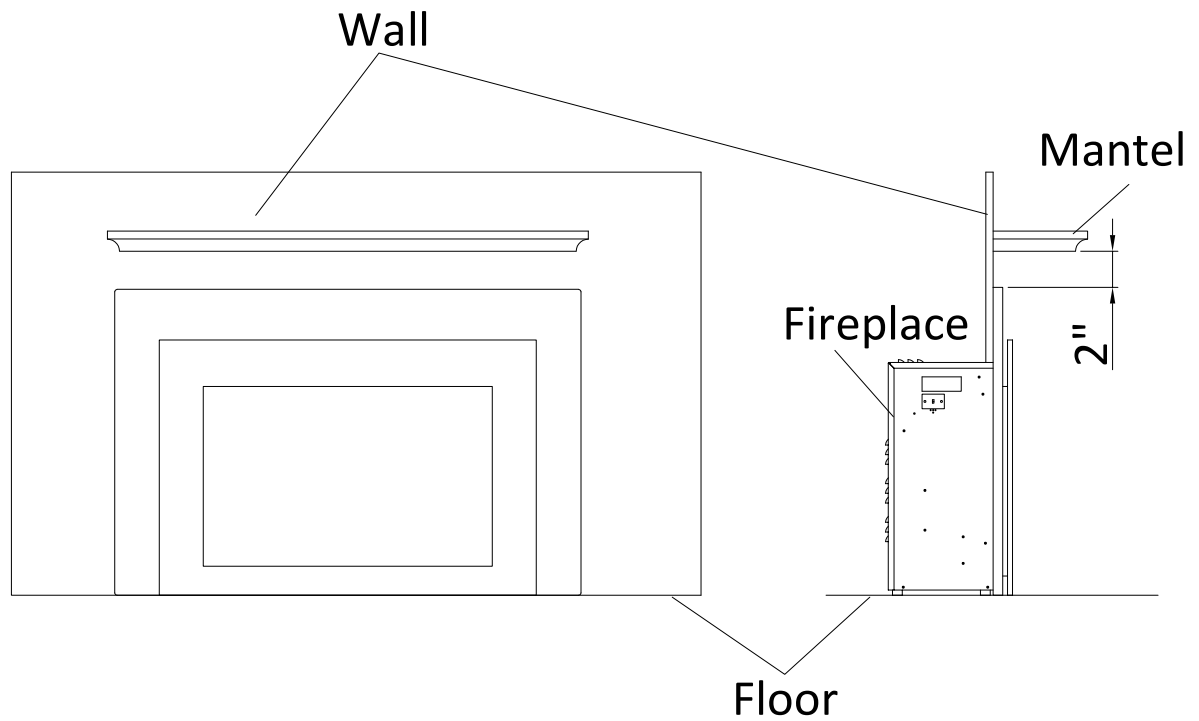

## HARDWIRE INSTALLATION

Turn off the appliance completely and let cool before servicing. Only a qualified service person should service and repair this electric appliance.

If it is necessary to hard-wire this appliance, a qualified electrician must remove the cord connection, and wire the appliance directly to the house hold wiring.

This appliance must be electrically connected and grounded in accordance with local codes, if hardwired. In the absence of local codes, use the current CSA C22.1 CANADIAN ELECTRICAL CODE in Canada or the current ANS/NFPA 70 NATIONAL ELECTRICAL CODE in the United States.

1. Remove the cover plate from the left side of the appliance by removing the two screws, as shown below. Unscrew and remove power cord.



2. Attach the wiring to the junction block. Please make sure the live wire goes into the "L", the neutral wire into "N" and the ground wire into "G".



3. Return the cover plate to the left side and screw the two screws back in to fasten the plate.

## MEDIA OPTIONS

Your fireplace shipped with the following media: sable glass and 6 piece log set. Customers can decorate their fireplace according to their wishes with supplied media.

This fireplace includes the following decorative media:



Sable



Log set

## MEDIA INSTALLATION

**STEP 1:** Unplug the unit and make sure control is switched off.

**STEP 2:** Unscrew 1 screw on each side and take off the trim.

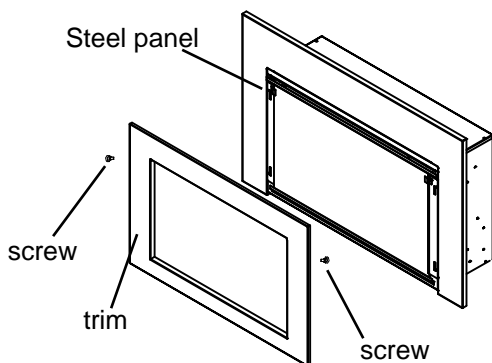

**STEP 3:** Unscrew 1 screw on left and right side and take off the steel panels that cover the front glass, remove the glass panel carefully.

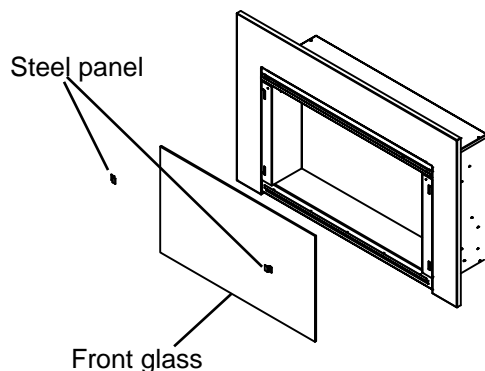

Now you can start to decorate your fireplace

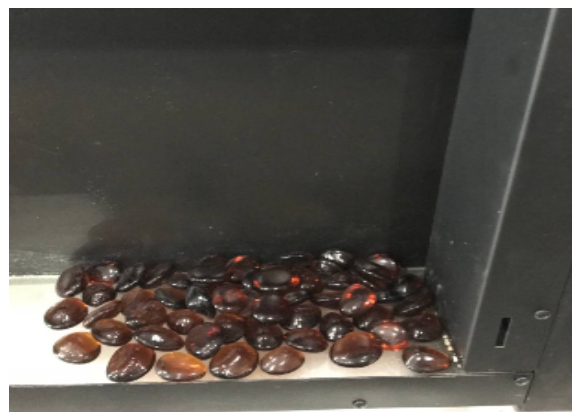

**STEP 3:** After finishing decoration, put back the front glass panel.







## OPERATION

The Fireplace operates by using either the touch panel located on the upper left hand corner or by remote control.

Plug the fireplace into a 15 Amp wall socket.

## MANUAL OPERATION



1. Press  to turn on and off the fireplace.
2. Press  to adjust the flame brightness. There are 6 brightness levels (L6-L1) and an off(OFF) position. Each time the flame button is pressed, the brightness of the flame decrease.  
  
press the flame button for 10 seconds, the timing indicator light on and will rapidly blinks, at this time, You can use the TuyaSmart APP to connect to the fireplace.
3. Press  to adjust the ember Bed /Moodlight brightness. There are 11 brightness levels (d11-d2), dynamic condition(d1) ,and the OFF(OFF) setting you can cycle through.
4. Press  to set the turn-off time, 30min-1h-2h-3h-4h-5h-6h-7h-8h-t0. The indicator light the current timing. If the timing in off position, the second press will show 30. Multiple times to set operating duration to OF, 30 min, 1h, 2h, 3h, 4h, 5h, 6h, 7h, 8h.
5. Press  or the first time to display the current setting temperature , press the button again to clear the current temperature. If the heater in off position, the second press will show 22°C (72°F). Multiple times to set ambient temperatures at 22°C ( 72°F ) , 23°C (74°F) , 24°C ( 76°F ) , 25°C ( 78°F ) , 26°C ( 80°F ) , 27°C ( 82°F ) , 28°C ( 84°F ) , 15°C ( 52°F ) , 16°C ( 54°F ) , 17°C ( 56°F ) , 18°C ( 58°F ) , 19°C ( 60°F ) , 20°C ( 62°F ) , 21°C ( 64°F ) .  
  
Temperature unit convert functionZ When the heater is on, press and hold the “” Button for 5 seconds, current temperature unit display will convert to another temperature unit.













## REMOTE CONTROL OPERATION

For remote to function make sure the fireplace is plugged in and the remote has batteries.

Important: When operating the remote make sure you point the remote to the center of the fireplace. Each time you press the button, the buzzer inside the unit will beep once. It takes some time for the receiver to respond to the transmitter. Do not PRESS the buttons more than once within two seconds for correct operation.

Set the current time of the remote control

Press the  to activate the remote control and press to set  the time and date. When one of the “Sun” “Mon” “Tue” “Wed” “Thu” “Fri” “Sat” is flashing, press  or  to set the day of the week, press  to confirm day of the week and then enter hour setting. Press  or  to set the hour, press  to confirm the hour and then enter minute setting. Press  or  to set the minute and press  to confirm the minute and finish time setting.

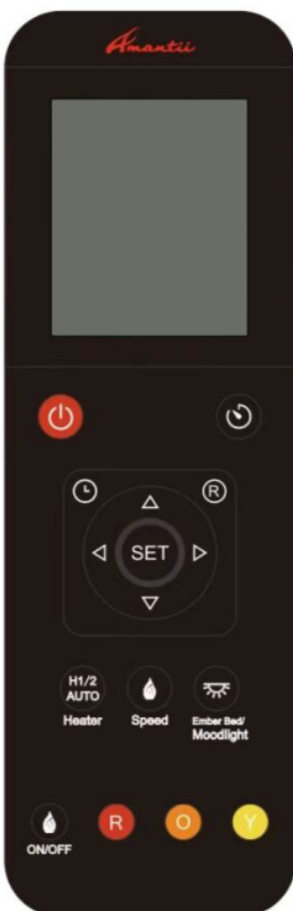

Press this Power button to turn on and off the fireplace.







Press this Timer button to set the time to turn off the fireplace. The available settings range from 30 minutes to 8 hours. As shown in the following: 0:30 - 1:00 - 1:30 - 2:00 - 2:30 - 3:00 - 3:30 - 4:00 - 4:30 - 5:00 - 5:30 - 6:00 - 6:30 - 7:00 - 7:30 - 8:00. Once you have set the timer, the  icon will be displayed on the LCD screen of the remote control. Press this button again to cancel the timer setting and the icon disappears.



Each time the Heater Button is pressed, the power of the heater will change. As shown the following: H1- H2- AUTO (22°C) - OFF (no display)

H1 means the fireplace on Low Heat/750W.



H2 means the fireplace on High Heat/1500W.

AUTO means fireplace can automatically adjust to the temperature you set. When in AUTO, you can set the desired temperature with  or  keys. You can switch temperature between Celsius and Fahrenheit with  or  keys. When it is on Auto mode, fireplace operate at 1500W.





Press this button to adjust the speed of the flame. There are 3 options: High- Medium- Low.













The Ember bed /moodlight Button turn the ember bed or moodlight on and off. When in on position, the display screen of the remote control shows AD1., when the number “1” flash, you can set the color with  or  keys. There are 10 different colors (AD1-10) and dynamic condition (AD11) to choose from.







Press the Flame button to turn on and off the Flame. When in ON position, the LCD screen of the remote control shows 6 6 6. Press  or  or  to change the brightness of each color flame.







### 7 Day Timer Function

Press  once, 7 days from Monday to Sunday will display on the LCD screen of the remote control, press  within 5 seconds to enter 7 day timer function. When “Sun” flashes, press  or  to select the day that you want to set, press  to confirm your setting. Then “ON” will be display on the LCD screen of the remote control, at the same time, digital of time hour flashes, press  or  to set the time to turn the fireplace on. After setting the startup time, “OFF” will be displayed on the LCD screen and press  or  to set the shutdown time. When the shutdown time’s set, “AUTO” will be displayed on the LCD screen of the remote control and the digital of temperature flashes. At this time, you can set the temperature by  or . Now, you have finished setting of this function.

When the 7 day timer's set, the icon  will be displayed on the LCD screen of the remote control. Press  again to cancel the 7 day timer and the icon  will disappears.

**NOTE:** If the 7 day timing  and the general timing  are set at the same time, the system will respond to an earlier shutdown time.

 Press Refer button to check the settings of 7 day timer. Press  or  to see the settings of the day of the week and  or  the settings of the startup and shutdown time.

## WIFI OPERATION

### INSTALL TuyaSmart life

There are 2 ways to install TuyaSmart;

1. Search for “TuyaSmart life” in the APP store on your phone, download and install.
2. Scan the QR code below with your mobile phone.



### WIFI SETTING AND FIREPLACE OPERATION

1. Create an account and log in.
2. When you log in, touch “+” (FIG.1) to enter in FIG.2. Touch “others” on the left corner first and then choose “Connector (Wi-fi)” to enter in FIG.3 to set your Wi-fi account and password.

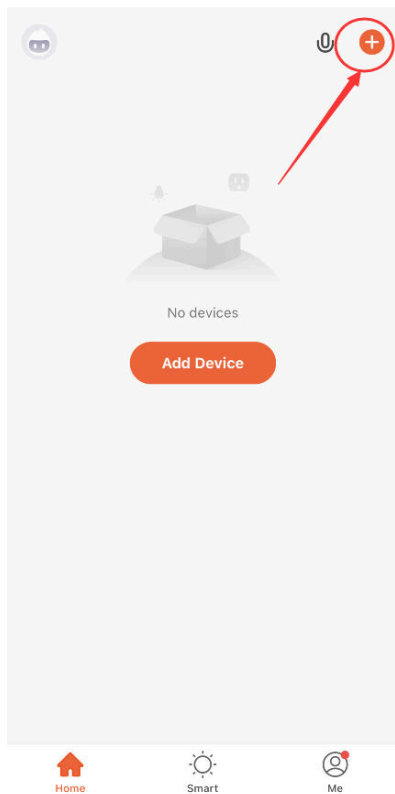

FIG.1



FIG. 2

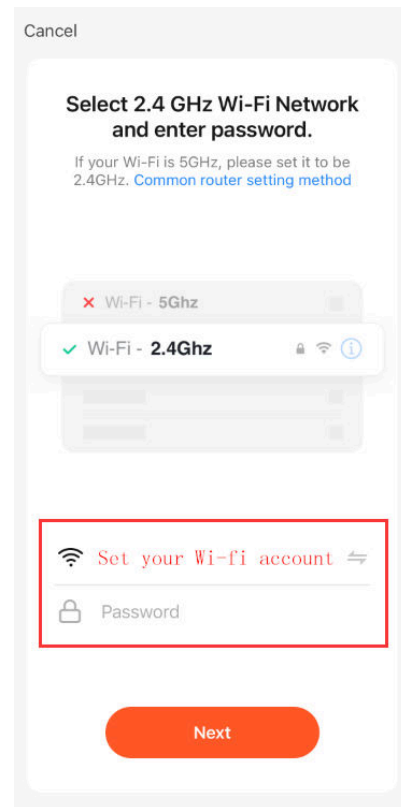



FIG.3



FIG.4

3. Press  (flame button) on the touch panel of the fireplace for more than 5 seconds when the fireplace is in standby mode. There will be 2 beeps come out from the fireplace and the  (flame button) will flash as well indicating that Wi-fi is in EZ mode. Then please confirm to go next. (FIG.5)
4. The APP will scan (FIG.6) and add the fireplace to APP (FIG.7) automatically. Please make sure the Wi-fi account and password you set are correct and Wi-fi signal is good.
5. Touch “Done” to finish Wi-fi setting.(FIG.7)

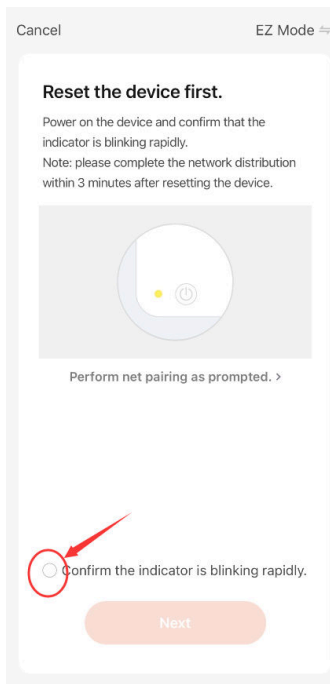

FIG.5

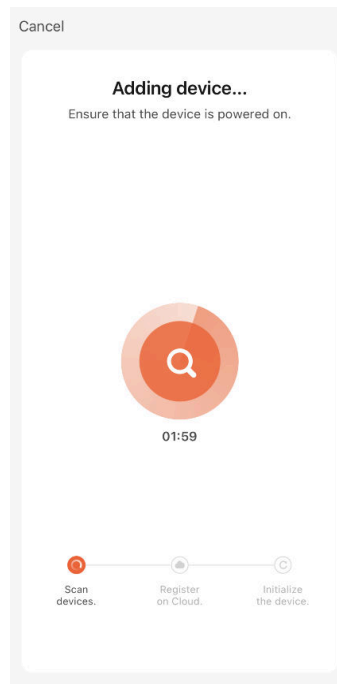

FIG.6

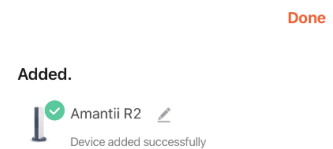

FIG.7

6. Now you are in the interface like FIG.7. You can operate the fireplace via Wi-fi.

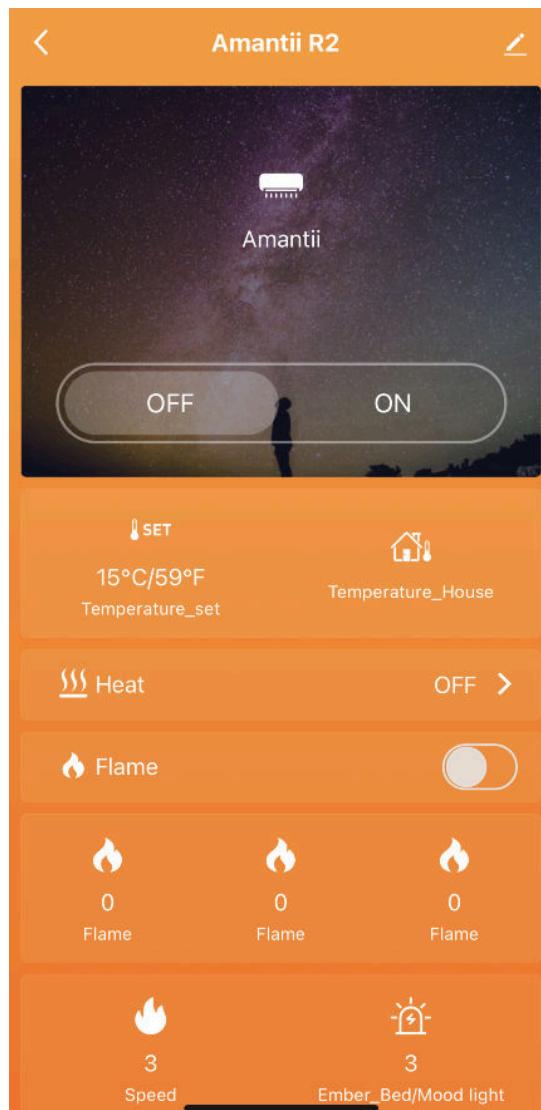

FIG.7

NOTE: Turn off the flashing blue Wifi indicator light



Touch the  (power button) once, the blue light will stop flashing.

**REPLACEMENT PARTS**

Ref.	Description	Quantity	INS-FM-30/INS-AMB-30	INS-FM-34/INS-AMB-34
			(INS-190030-1)	(INS-190034-1)
1	Trim	1	3103502	3104502
2	Adjustable screws	0	Not applicable	Not applicable
3	Front glass bracket	0	Not applicable	Not applicable
4	Front glass	1	10701184	10701185
5	Back glass	1	107021031	107021041
6	Tray glass	1	10702132D	10702214
7	Side glass	0	Not applicable	Not applicable
8	Black glass - Left	0	Not applicable	Not applicable
9	Black glass - Right	0	Not applicable	Not applicable
10	Glass bracket - Left	1	3103005	3104007
11	Glass bracket - Right	1	3103006	3104008
12	Adjustable leveling feet	4	10203015	10203015
13	Flicker assembly for Flame	1	3214505	3243505B
14	Flicker assembly for Tray	0	Not applicable	Not applicable
15	Flame motor	1	10101501B	10101501B
16	Heater / blower assembly	1	602082	602082
17	LED light set for flames	2	601146	601146
18	LED light set for ember bed / Tray lighting	Qty Required Based on Size of Unit	601136C – Qty 2	601136C – Qty 1
				601137C – Qty 1
19	LED light set for canopy light	Qty Required Based on Size of Unit	601140B – Qty 1	601139B – Qty 2
20	Temperature sensor	1	10114001B	10114001B
21	Remote signal receiver	1	601002B	601002B
22	Remote control	1	10105501	10105501
23	Circuit board	1	10124129	10124129
24	AC adapter	1	10116003	10116003
25	Circuit board for touch panel	1	10124003	10124003
26	Circuit board for touch pad	0	Not applicable	Not applicable
27	WiFi card	1	212051	212051
28	Power cord	1	10103014	10103014

\*Items may not appear exactly as illustrated

# EXPLODED VIEW

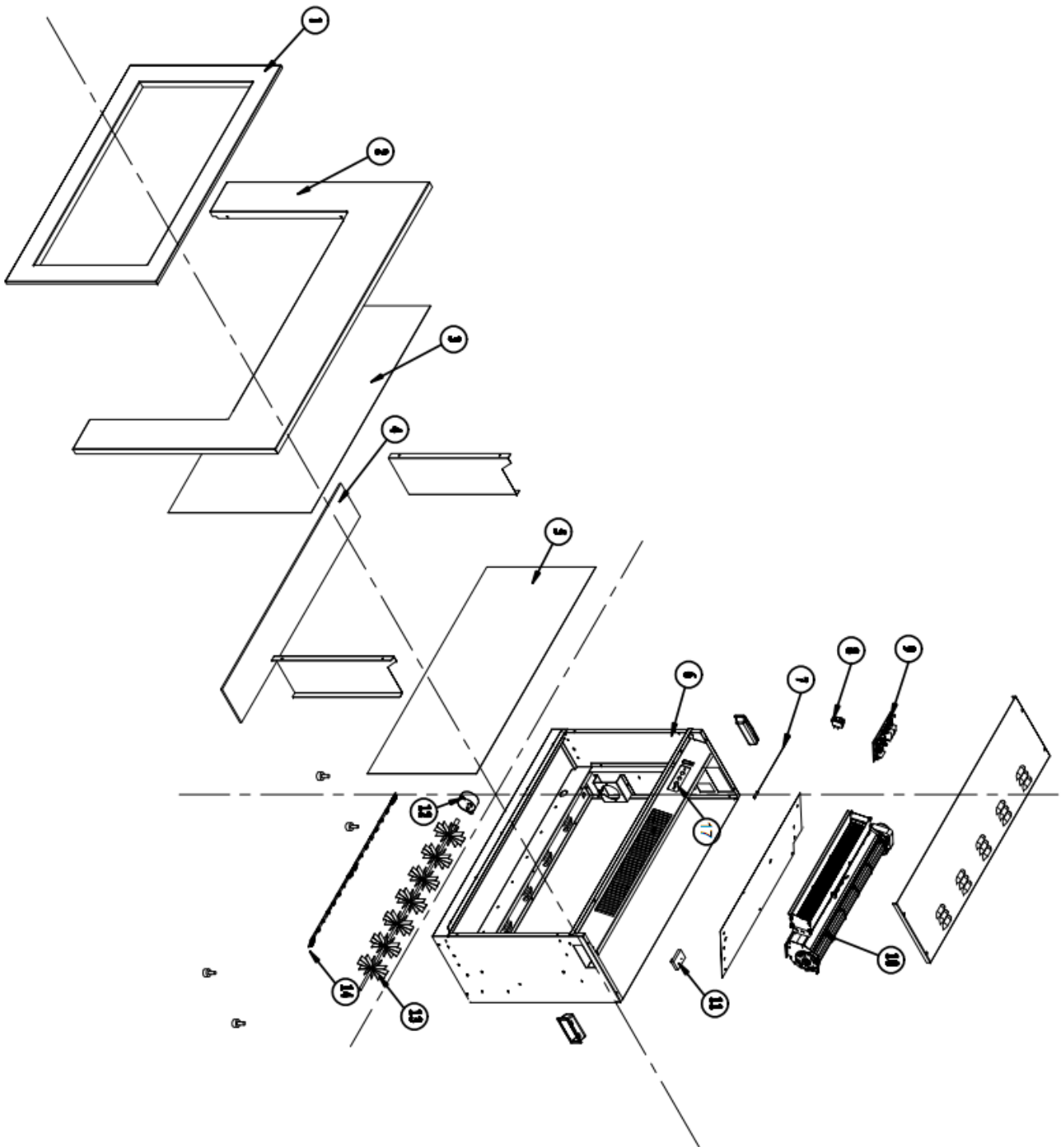



## TROUBLE SHOOTING

<b>PROBLEM</b>	<b>POSSIBLE CAUSE</b>	<b>SOLUTION</b>
Dim or no flame	Flame LED's are burnt out	Inspect the LED's and replace them if necessary.
	Back black cloth is falling off and roll the flicker	Change a new flicker and back black cloth.
Ember bed is not glowing or dimming	Ember LED's are burnt out	Inspect the ember bed LED's and replace them if necessary.
Appliance turns off and will not turn on	Appliance has overheated and safety device has caused the thermal switch to disconnect	Turn off the main switch, allow appliance to cool for 10 minutes, then turn it on.
	House circuit breaker has tripped	Reset house circuit breaker.
	Appliance's fuse has blown	Replace the fuse.
Appliance will not come on when switch is flipped to ON	Appliance is not plugged into an electrical outlet	Check plug and plug in.
	Appliance has overheated and safety device has caused the thermal switch to disconnect	Turn off the main switch, allow appliance to cool for 10 minutes, then turn it on.
	Circuit board is burnt out	Inspect the circuit board and replace it if necessary.
No warm air coming out of appliance	Heater is burnt out	Inspect the burner and heater assembly and replace it if necessary.
Flame sputters	Flame motor is defective.	Call a qualified service technician and replace flame motor.
Remote Control does not work.	Low batteries. Unit switch in "O" position.	Replace AAA batteries in remote control. Turn the switch in "I" position.
Flame is fixed.	Wiring may be loose or the flame motor may be defective.	

## SERVICE HISTORY

This heater must be serviced annually depending on usage.

Date	Dealer Name	Service technician Name	Service Performed	Special Concerns

## NOTES:

---

---

---

---

---

---

---

---

---

---

---

# ELECTRIC FIREPLACE WARRANTY

## FOR PRODUCTS MANUFACTURED AFTER JANUARY 1, 2016



Amantii Imports Corp. ("Amantii") warrants that your newly purchased Amantii electric fireplace is free from manufacturing and material defects for a period of two (2) years from the date of the first purchase, subject to the conditions and limitations contained below.

### WARRANTY APPLICATION & EXCLUSIONS

This limited warranty applies to your newly purchased Amantii electric fireplace; the limited warranty's application is limited to purchases made in any province of Canada or in any of the 52 States of the United States of America, including the District of Columbia. Only the original purchaser of the product is eligible for coverage under this limited warranty; the warranty is not transferable.

### PRODUCTS EXCLUDED FROM THIS LIMITED WARRANTY

Light bulbs are not covered by this limited warranty and are the sole responsibility of the owner/purchaser.

### WARRANTY COVERAGE AND TERM

Products covered by this limited warranty have been tested and inspected prior to shipment and, subject to the provisions of this warranty, Amantii warrants such products to be free from defects in material and workmanship for a period of two (2) years from the date of the first purchase of such products.

The limited two (2) year warranty period for products also applies to any implied warranties that may exist under applicable law. Some jurisdictions do not allow limitations on how long an implied warranty lasts, so the above limitation may not apply to the purchaser.

All other warranties—expressed or implied—with respect to the product, its components and accessories or any obligation/liabilities on the part of Amantii are hereby expressly excluded.

### WARRANTY COVERAGE AND TERM - BESPOKE SERIES

Products covered by this limited warranty have been tested and inspected prior to shipment and, subject to the provisions of this warranty, Amantii warrants such products to be free from defects in material and workmanship for a period of five (5) years from the date of the first purchase of such products.

The limited five (5) year warranty period for products also applies to any implied warranties that may exist under applicable law. Some jurisdictions do not allow limitations on how long an implied warranty lasts, so the above limitation may not apply to the purchaser.

All other warranties—expressed or implied—with respect to the product, its components and accessories or any obligation/liabilities on the part of Amantii are hereby expressly excluded.

### LIMITATIONS TO COVERAGE UNDER LIMITED WARRANTY

This limited warranty does not apply to products that have been repaired, except by Amantii or its authorized service representatives, or otherwise altered. This limited warranty further does not apply to defects resulting from misuse, abuse, accident, neglect, incorrect installation, improper maintenance or handling, or operation with an incorrect power source. Products made by other manufacturers, sold with the product or thereafter, are not covered by this limited warranty. The use of unauthorized components will render this warranty null and void.

### PANORAMA OUTDOOR UNITS

All Panorama units that are installed outdoors or in moisture intense conditions must use the stainless steel cover. Proof of purchase of the cover is required for any warranty claims.

### SERVICE UNDER LIMITED WARRANTY

Defects must be brought to the attention of Amantii Technical Support by contacting Amantii at (1.877.850.9458), or at 502-1027 Davie Street, Vancouver, BC V6E 4L2. Please have your proof of purchase, catalogue/model and serial numbers available when calling; any and all service under the limited warranty requires a proof of purchase of the product.

### DEFECTS

Should a product or part covered by this limited warranty be proven to be defective, in material or workmanship, and during the two (2) year limited warranty period, Amantii will replace such defective product or part without charge. If Amantii is unable to replace such product, or if replacement is not commercially practicable or cannot be timely done, in its sole discretion Amantii may, in lieu of replacement, choose to refund the purchase price for such product or part.

# ELECTRIC FIREPLACE WARRANTY

## FOR PRODUCTS MANUFACTURED AFTER JANUARY 1, 2016

### APPLICATION OF PROVINCIAL AND STATE LAW

This limited warranty gives you specific legal rights, and you may also have other rights which vary from jurisdiction to jurisdiction. The provisions of the United Nations Convention on Contracts for the Sale of Goods shall not apply to this limited warranty or the sale of products covered by this limited warranty.

### GENERAL

Amantii reserves the right to make changes at any time without notice, in design, material, specifications, prices and the right to discontinue styles and products.

### GLASS

This limited warranty does not apply to the following glass products:

Model Type	Tray Glass	Front Glass	Back Glass
Panorama /Symmetry	✓	✓	✓
Wall Mount/ Insert	✓		
Traditional	✓		
Zero Clearance/ FS	✓		
Freestand	✓		

### EXCLUSION OF BATTERIES

Ocean carriers have set new rules designed to protect the safety of shipments while in transit. This new rule disallows the inclusion of lithium/alkaline batteries, as a result we will no longer be including batteries with the fireplace remote.

### REPLACEMENT MOTORS

With the reliability of the components used in the construction of our electric fireplaces, a complimentary replacement motor will no longer be included inside the carton containing the fireplace.